

Falcon Panel Products

STREDOR®

Production of UKCA Marked Doorset System

Stredor E30 FED

Stredor EI30 FED

Stredor EI30Sa FED

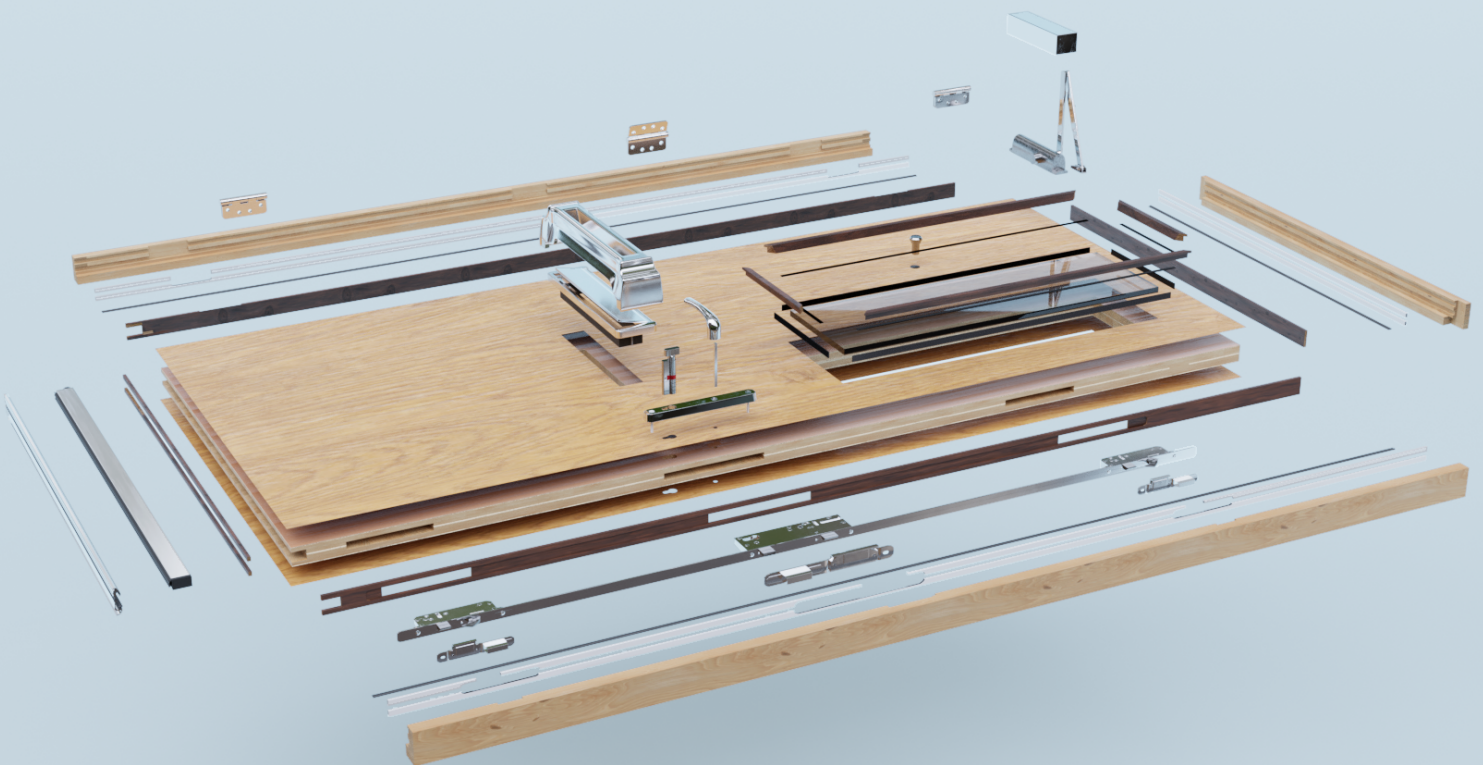

Contents

1. Introduction	4
1.1 Manufacturing a Stredor® UKCA Marked Doorset System	4
1.2 Using this manual	4
2. Door Leaf	6
2.1 Core preparation, lipping and facing	6
2.2 Leaf recessing	8
2.3 Leaf finish	9
2.4 Glazing	10
2.5 Leaf Hardware	12
3. Door Frame	14
3.1 Frame profiling	14
3.2 Frame seals and hardware recessing	15
3.3 Frame finish	15
3.4 Frame Assembly	16
4. Doorset	17
4.1 Final Assembly	17
4.2 Declaration of Performance	18
4.3 Labelling for UKCA Mark	19
4.4 Labelling for Fire and Security Certification	19

1 Introduction

1.1 Manufacturing a Stredor® UKCA Marked Doorset System

This manual provides guidance for manufacturers producing UKCA Marked, fire rated external doorsets using the Falcon Panel Products Stredor® Front Entrance Doorset (FED) system.

Since October 2019 it has been a mandatory requirement under the CPR for manufacturers within the EU to UKCA Mark external fire rated pedestrian doorsets using harmonised product standards EN 14351-1 and EN 16034.

Falcon Panel Products Ltd operates as a Systems House and is therefore able to cascade initial type testing and other supporting evidence to manufacturers (or “fabricators”) using its Stredor® Front Entrance Doorset system.

In order for manufacturers to produce UKCA Marked fire rated external doorsets using this system, please be aware that UKCA Marking for fire rated doorsets is controlled under AVCP System 1 and therefore, it is mandatory that the services of a suitable Notified Body are used in order to certify this doorset system.

It is not possible to legitimately UKCA Mark external fire rated doorsets *solely* by manufacturing in accordance with and presenting this manual.

In order for a manufacturer to prepare a Declaration of Performance (DoP) and UKCA Mark the products they place on the market at AVCP System 1, a manufacturer must have been issued with a Certificate of Consistency of Performance (COCOP) following the necessary conformity assessment tasks by the Notified Body. The Notified Bodies with whom we have worked for this system are BM Trada and Warringtonfire.

Falcon Panel Products Ltd are here to help at every stage of your UKCA Marking activities.

1.2 Using this manual

Icons

Icons are used throughout this manual to indicate 3 distinct types of information.

 **Instruction**- Must be followed in order to produce a certified Stredor® UKCA Marked Doorset System.

 **Guidance**- Steps during manufacture that are optional, or tips to help with the manufacture process.

 **Reference**- Pertinent information is contained elsewhere in this manual, or outside information that is pertinent to the manufacture process.

Flowchart

The flowchart on page 5 of this manual provides a brief overview of the manufacturing process of a Stredor® UKCA Marked Doorset System.

Click a process name to navigate to the correct page.

Reference Tables

Please see section 4.5 for detailed tables of approved hardware, hardware intumescent protection, intumescent seals and smoke and weather seals. All items in the tables are clickable, with links to the manufacturers website.

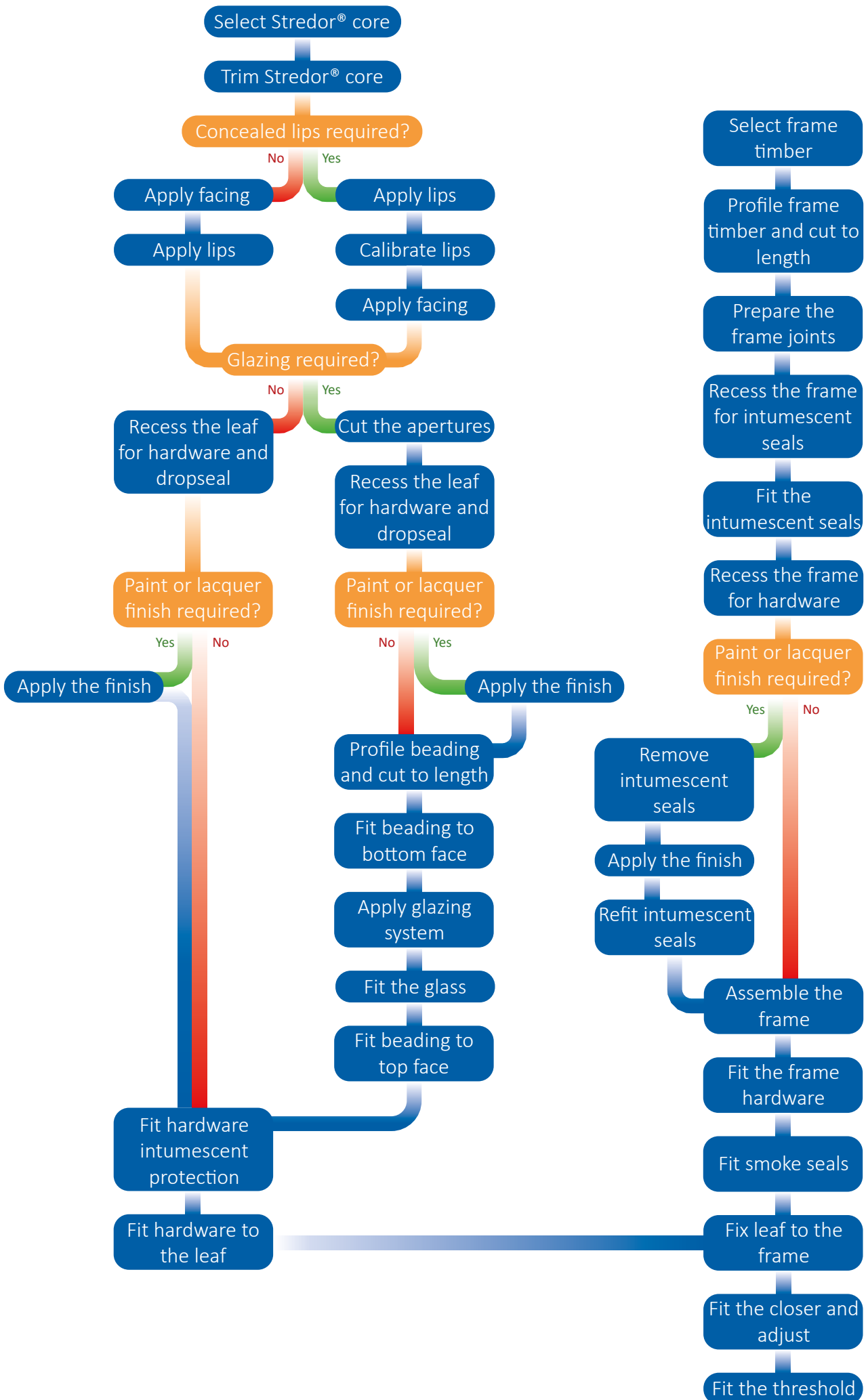

2 Door Leaf

2.1 Core preparation, lipping and facing



Select Stredor® 44mm core.



Check for any damage or defects. If any are present either reject, or ensure that damage can be removed during processing.

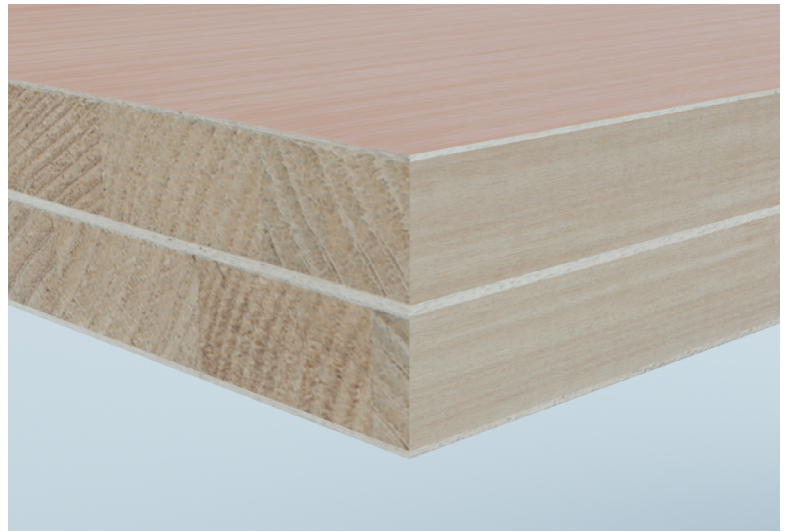

Cut core to required height and width, allowing for the thickness of lippings in desired finished leaf size. Ensure that the cut core is square and true.



To check that your core is square, measure the opposing diagonal corners and make sure the measurements are the same.

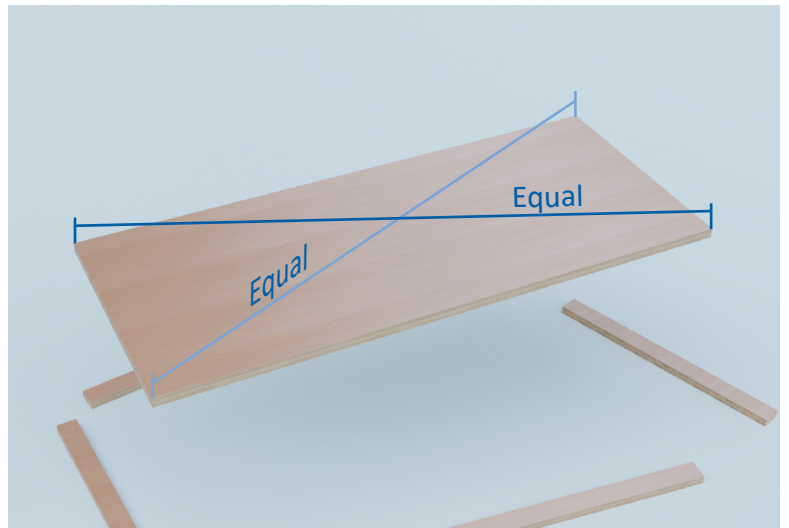

Select lippings to required dimensions. An approved timber species and density should be selected. Lippings should be 6 – 12mm thick to all four edges.



Lippings should be straight grained, joinery quality, and free from knots split and checks.

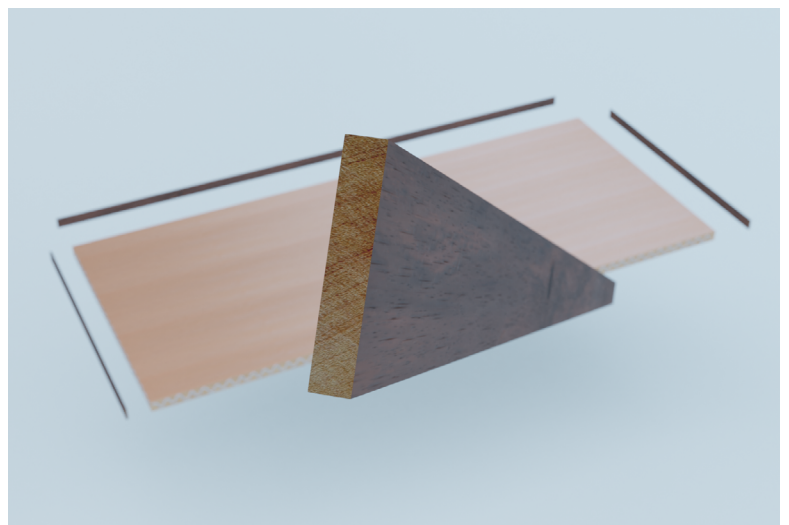



Apply lippings to the core. Lippings should be applied using the specified PU or PUR adhesive. Lippings should be applied to all four edges of the core.



Lippings can be hand applied and clamped, or applied using an edge bander.

If lippings are hand applied, use Norbord Caberfix D4 PU adhesive.

If lippings are edge banded, use Technomelt PUR 270/G adhesive.

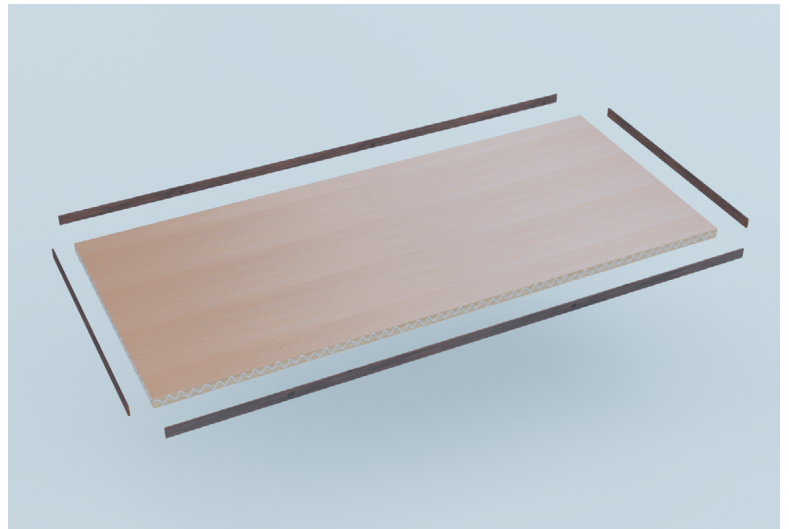

If required, apply facings using a suitable adhesive for bonding the chosen material onto a timber base.

For longevity, ensure the selected facing, adhesive and bonding method is suitable for the environment that the doorset will be subject to.

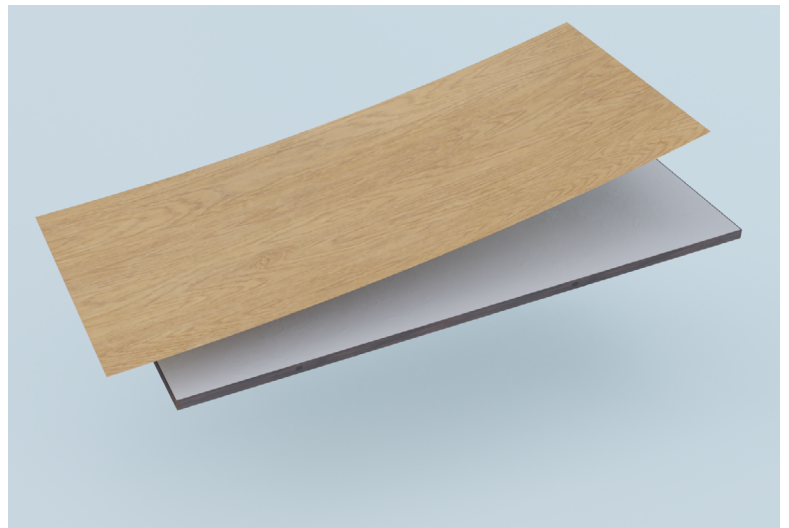

Facings should be as approved within the relevant EXAP document. Options include timber veneer up to 3mm thick, laminate, plastic, cloth, leather etc. up to 2mm thick.



Trim any facings as required.



A small (<2mm) chamfer or radius may be used to ensure clean lines.



2.2 Leaf recessing



Prepare the leaf for ironmongery and seals, including hinges, multipoint lock, spindle and cylinder, concealed closer, letter plate, spy hole and drop seal, dependant on requirement.

Follow the manufacturer's instructions for leaf preparation of each item of hardware.

Ensure allowances are made for intumescent protection as required in the relevant EXAP document.



Check that the hardware fits tightly into the recessing when fitted with intumescent protection.

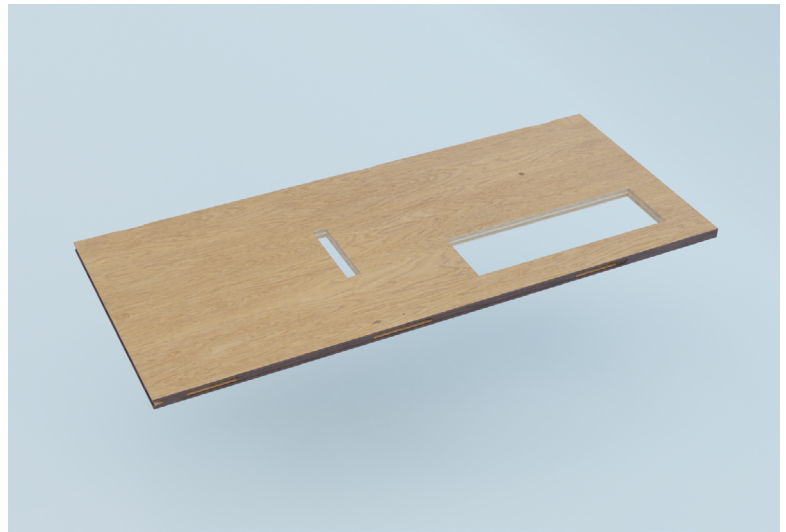

Hardware Positioning



The top hinge may be located between 100 - 150mm from the top of the door leaf to the top of the hinge.

The bottom hinge may be located between 100 - 180mm from the bottom of the leaf to the bottom of the hinge.

The intermediate hinge was tested at 759mm from the top of the hinge to the bottom of the top hinge and 758mm from the bottom of the the hinge to the top of the bottom hinge.

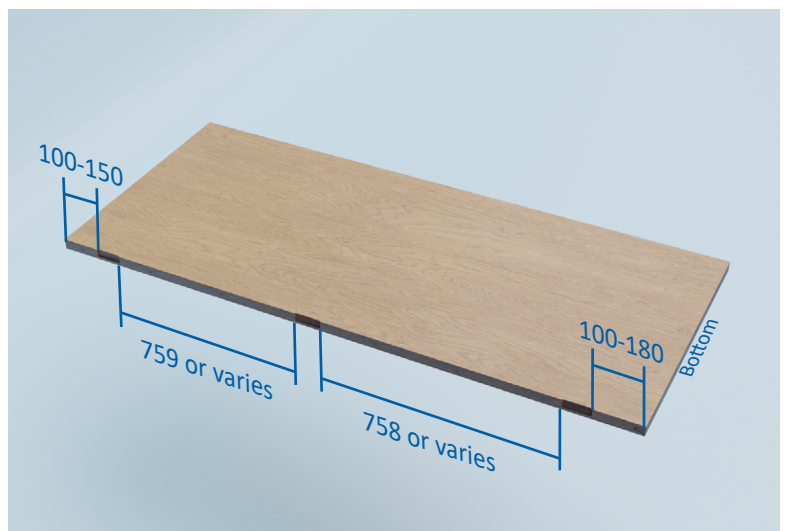

It is permitted to move the intermediate hinge, but the distance between the top hinge and intermediate hinge **or** the intermediate hinge and the bottom hinge must remain as tested. If either of these distances cannot be maintained it is permitted to add an additional hinge so that the maximum distance between hinges is not increased.



Astra 4003 Jamb mounted closers must remain as tested at 849mm from the bottom of the door leaf to the centreline of the closer.



ERA Fab&Fix Numail letterplate must remain as tested at 850mm from the bottom of the leaf to the centreline of the letterplate. The letterplate can be moved to the side, but must be no closer than 145mm to the edge of the door leaf. Additionally, the cut out for the letterplate must be no closer than 125mm from any other aperture in the leaf.



Sealed Tight Solution 4008 or ERA Fab&Fix Spyhole must be positioned at least 150mm from the edge of the door leaf and 125mm from any other aperture in the leaf.



Cut out the required aperture dimension. The maximum glazed area is 0.6m², and the aperture must be a minimum of 150mm from the edges of the leaf, with a minimum of 140mm between apertures.



The required expansion space (gap between the glass and the aperture) for the approved glass is 5mm, ensure that this is allowed in the aperture dimension.

Allow for the beading bolection when deciding the placement of the aperture.



2.3 Leaf finish



If required, apply primer, paint or lacquer finish to the leaf and/or lippings. Ensure that finishes adhere to the thicknesses and materials required by the relevant EXAP document. Glazing beads can be painted or lacquered separately, or the leaf can be glazed prior to finishing and finished as one.

2.4 Glazing



Select beadings to the required dimensions, and mitre to length. An approved timber species should be selected.

Beading should be 22mm high x 19mm wide, with a 15° chamfer and a 6 x 6mm bolection.



Beading timber should be straight grained, joinery quality, and free from knots split and checks.



Fix the beading to one face. The beading must be fixed using 16-gauge x 50mm long SSS pins.

Fixings must be inserted at 50mm from each corner, and at a maximum of 150mm centres in between. The fixings should be inserted at 35° to the plane of the glass.



Apply glazing tape to the fixed beading cassette, and the loose beading cassette.

Apply glazing liner to the centre of the reveal of the aperture if required.



Note that differing classifications require differing glazing systems.



Please see the table in section 4.5 for details of the approved glazing systems.

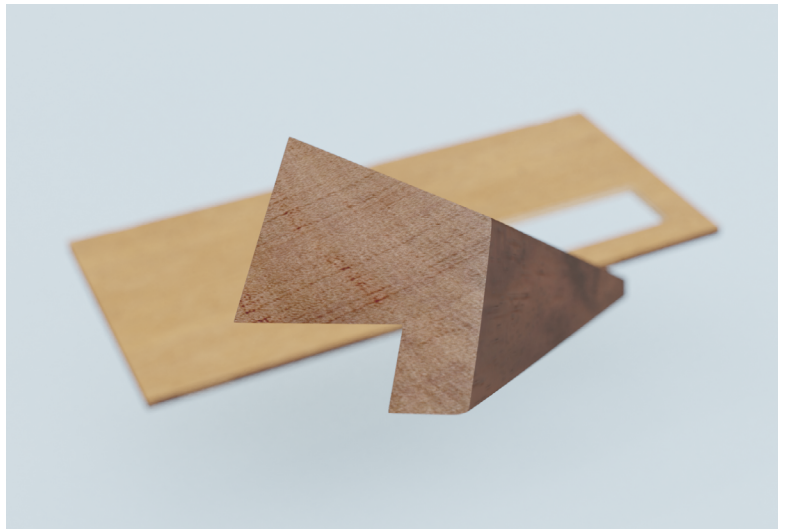



Fit Pilkington 15mm Pyrostop glass into the aperture.

You should allow a 5mm expansion between the glass and the aperture. Ensure that the glass is central in the aperture with an equal expansion gap at all edges.



Ensure that any stamps on the glass are correctly orientated and visible for future inspection.



Fix the beading (with glazing tape applied) to the open face, using the same fixing details as previous.



Glazing pins may be concealed with timber wax filler.





2.5 Leaf Hardware

 Fit the intumescent protection for the hinges and ERA SureFire lock.

 Ensure that the intumescent protection does not interfere with the operation of the lock.



 Fit the hinges, ERA Surefire lock and drop seal, using the fixings supplied and following the manufacturer's installation instructions.

 The drop seal should be centrally rebated into the bottom of the leaf.

 See the seal options in section 4.5 for dropseal details.

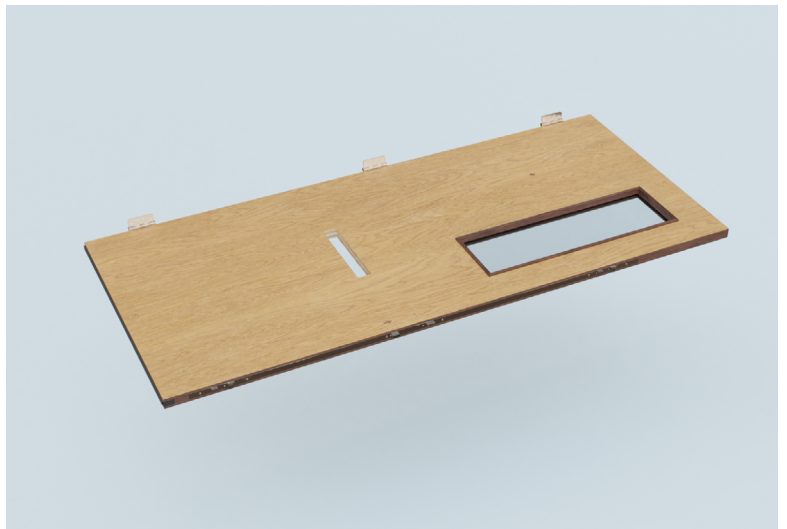

 Fit the letter plate, security cowl and spy hole with the appropriate intumescent protection.





Fit the lock spindle and the lever handles using the fixings supplied and following the manufacturer's installation instructions.



Lever handles may be supplied loose for site fix to aid with packing and transportation of doorsets.



Fit the ERA Fortress 3* cylinder using the machine screw supplied.



Ensure that the thumbturn is fitted to the pull face.



Please see the table in section 4.5 for details of the approved hardware, approved hardware intumescent protection, and smoke and weather sealing relevant to the door leaf.

3 Door Frame

3.1 Frame profiling



Select timber of an approved species, that is profiled to the correct dimensions. The door leaf must be framed on both long edges and the top.



Ensure that the timber is straight grained, joinery quality, and free from knots, splits and checks. Any minor defects should be orientated away from the leaf.



The frame must be a minimum of 70mm deep x 44mm thick, including a 15mm thick rebated stop. The frame should not overhang the wall on either side.



The stop rebate should allow for the leaf thickness + 3mm, so allow for any facings on the 44mm core.



Cut frame components to the correct length, and prepare a 12mm trench joint.

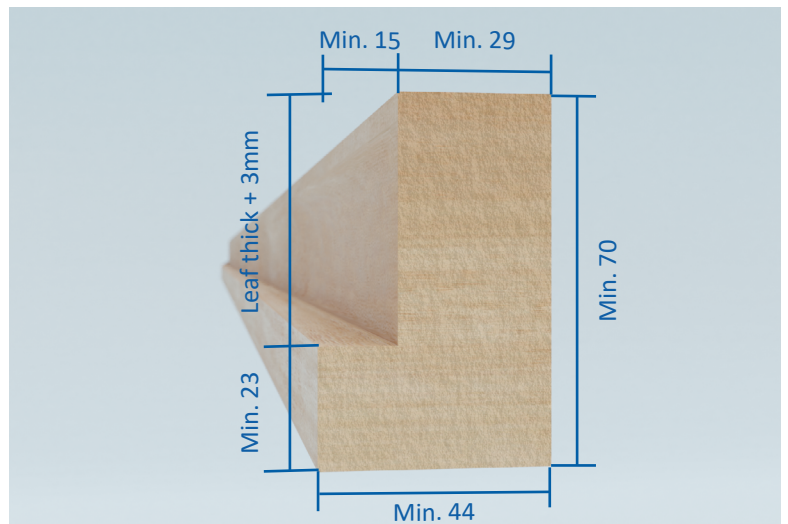
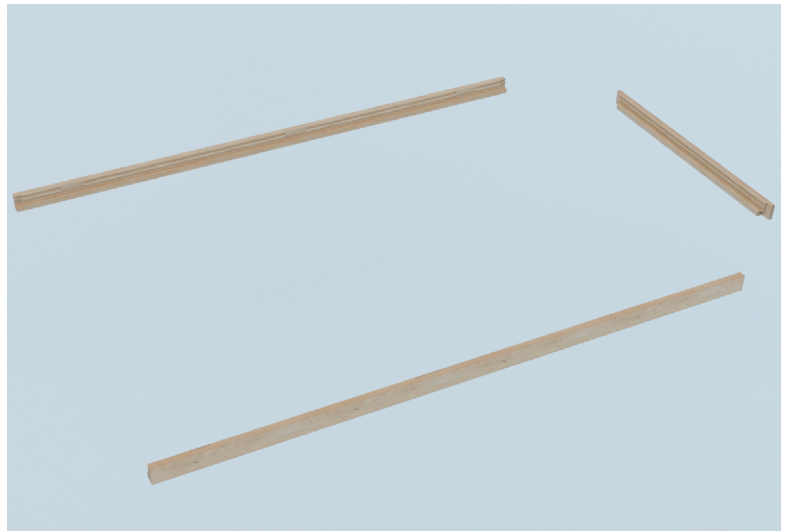

3.2 Frame seals and hardware recessing



Prepare the frame for 2no 10x4mm Sealed Tight Solutions STS104FO intumescent seals.



If the frame will have a paint or lacquer finish, allow for this in the size of the intumescent groove.

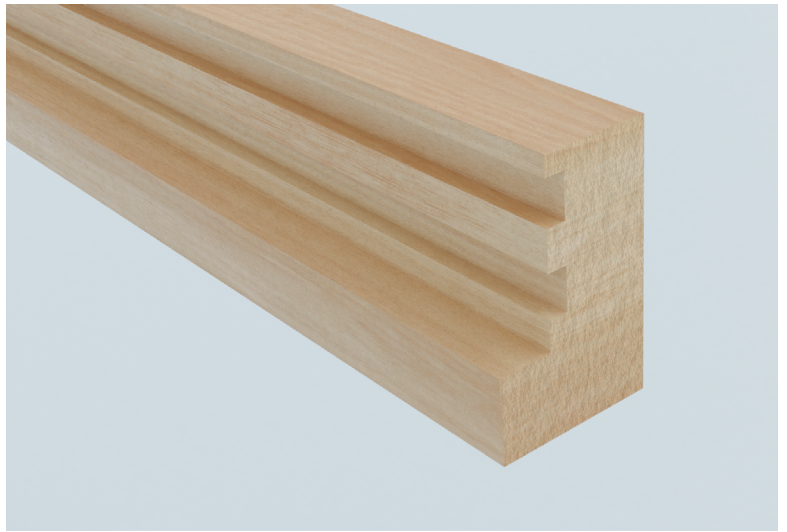

Fit the intumescent seals to the frame. If the frame will have a paint or lacquer finish, only loose fit at this point.

Prepare the frame for the hinges and lock keeps, routing through the intumescent strips to get a clean cut.



Allow for the required intumescent protection behind the keeps and hinges.



3.3 Frame finish



If required, apply primer, paint or lacquer finish frame. Ensure that finishes adhere to the thicknesses and materials required by the relevant EXAP document.

Remove the loose fitted intumescent strips, finish the frame, and then fully re-fit the intumescent strips.

3.4 Frame Assembly



Assemble the frame using PVA D4 adhesive and wood screws. Each joint must have 4no 5x80mm steel screws.



Ensure that the frame is square by using the same method as the leaf - ensure that the diagonal measurements are the same.

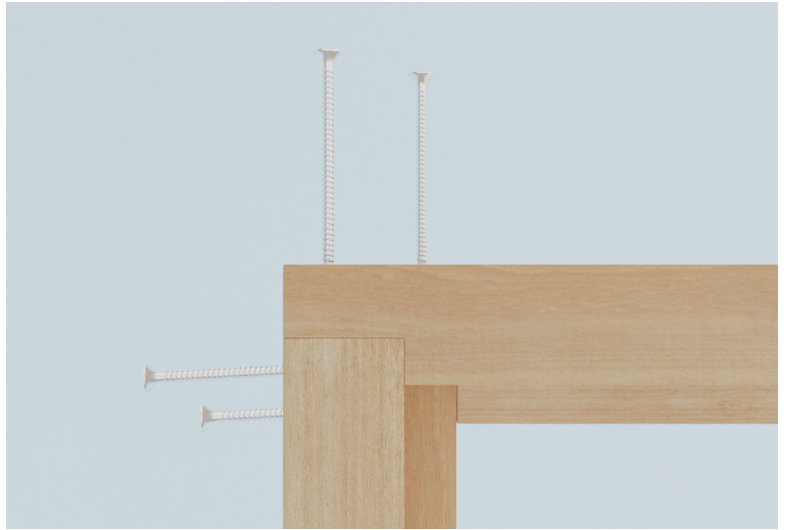

Fit the smoke seals. The seals should be fitted to the doorstep.



See the seal options in section 4.5 for smoke seal details.

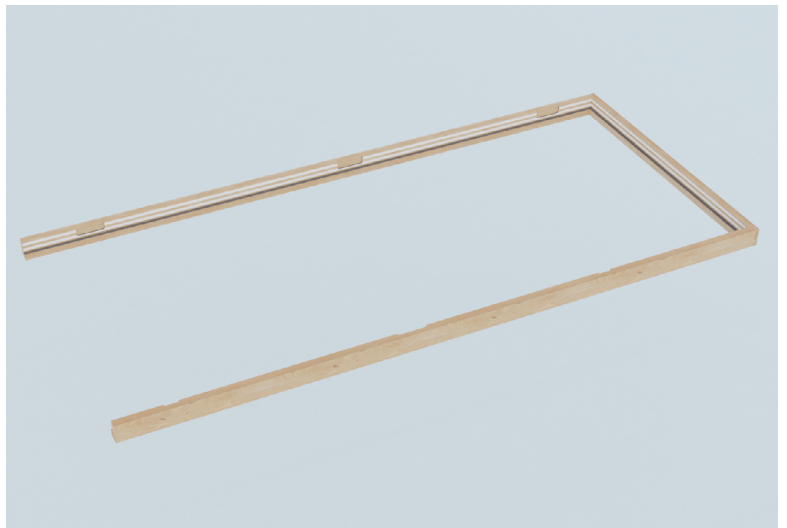

Fit the intumescent protection to the hinges and multipoint lock keeps. Fit the multipoint lock keeps using the fixings supplied and following the manufacturer's installation instructions.



Ensure that the intumescent protection is fitted neatly to reduce visibility once the hardware is fitted.

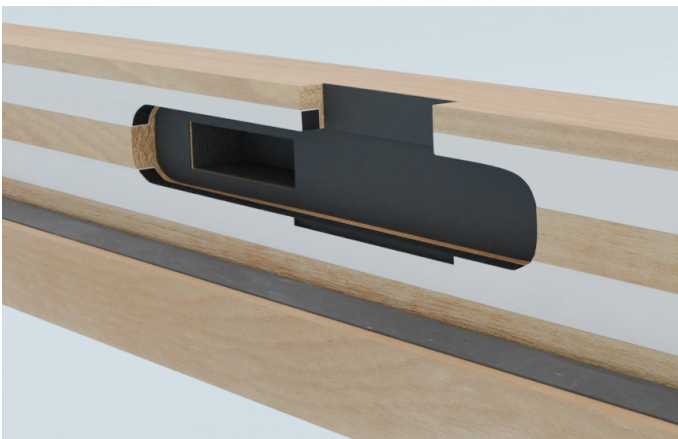

4 Doorset

4.1 Final Assembly



Fix the hinges to the door leaf. Line up the leaf with the frame and fix the hinges into the frame.



Position the leaf at around 90° to the frame.

Use packers or wedges at the bottom of the leaf to help line it up with the frame. Take care not to damage the bottom of the leaf or the dropseal.

Leafs may be supplied loose from the frame for site fix to aid with transportation but should be test hung prior to delivery.



Ensure smooth operation of all elements and that correct operating gaps have been maintained between leaf and frame.



Operating gaps should be between 2.5 and 4mm.



Face fixed closers and thresholds may be supplied with the door set for site installation.





For details of installation, please see the Falcon Panel Products Stredor® 'Installation of UKCA Marked Doorset System' document FPP-IM-SD-601.

4.2 Declaration of Performance

 Manufacturers of a Stredor® UKCA Marked Doorset System are required to draw up a Declaration of Performance (DoP) in a stipulated format, that lists the mandated characteristics in harmonized standards EN 14351-1:2006+A2:2016 and EN 16034:2014+A1:2016, and shows the performance of the product within those categories.

The DoP should allow for easy comparison of performance information.

 The DoP should be made available for download, and in hard copy if requested.

 See an example of a Declaration of Performance below.

Regulation (EU) 305/2011 Declaration of Performance No: Stredor® FED Doorset System		
<p>1. Unique identification code of the product type: Stredor® FED Doorset System 2. Intended use: Communication in domestic and commercial locations; fire, smoke and security compartmentation and/or escape routes 3. Manufacturer: Door Manufacturing Ltd 4. Systems of AVCP: System 1 and 3 5a. Harmonised standards: EN 14351-1:2006+A2:2016 & EN 16034:2014+A1:2016 5b. Notified bodies: BM Trada (UK) (Notified Body 1124) issued a certificate of constancy of performance and carried out type testing and calculation 6. Declared Performance:</p>		
Essential Characteristics	Declared Performance	Harmonised Standard
Watertightness	Class 3A	EN 14351-1:2006+A2:2016
Dangerous substances	None	
Resistance to wind load	NPD	
Impact resistance	NPD	
Height	Varies	
Acoustic performance	33dBRw	
Thermal transmittance	1.8 W/m ² K	
Radiation properties	NPD	
Air permeability	NPD	
Resistance to fire (for fire compartmentation uses)		
E:	30	
EI1:	NPD	
EI2:	30	
EW:	NPD	
Smoke control	SA	
Ability to release	NPD	
Self-closing	C	
Durability of ability to release	NPD	
Durability of self-closing		
Against degradation (cycle testing):		
Against ageing (corrosion):		
<p>7. The performance of the product identified above is in conformity with the set of declared performances. This declaration of performance is issued, in accordance with Regulation (EU) No 305/2011, under the sole responsibility of the manufacturer identified above.</p> <p>Signed for and on behalf of the manufacturer by: Mr. Phil Wallhole (Managing Director) Dorset, 3rd March 2021 Signature: <i>P. Wallhole</i></p>		

4.3 Labelling for UKCA Mark

 Manufacturers are required to provide sufficient information to ensure traceability of the product. A link should be established between the product, the manufacturer and the production (this can be achieved by means of products codes). The information should be contained on a product label, in detailed in accompanying documents, and in the manufacturers published Declaration of Performance.

 Relevant information from the DoP or manufacturers technical documents can be referenced on the product label, or the product label can carry reference to such documents to enable the user to find the documentation. Information should be made available regarding the handling, installation, and maintenance of the product, and this can be referenced on the label. The label can also carry details of the intended use of the product.

 See an example of a label below.
See Falcon Panel Products 'FPP-IM-STDR-501-A - Installation of UKCA Marked Doorset System' for details of handling, installation and maintenance of a Stredor® UKCA Marked Doorset System.

UK CA	Door Manufacturing Ltd, Dorset Product Code: Stredor® FED Doorset System	
Essential Characteristics	Declared Performance	Harmonised Standard
Watertightness	Class 3A	EN 14351-1:2006+A2:2016
Dangerous substances	None	
Resistance to wind load	NPD	
Impact resistance	NPD	
Height	Varies	
Acoustic performance	33dBRw	
Thermal transmittance	1.8 W/m ² K	
Radiation properties	NPD	
Air permeability	NPD	
Resistance to fire (for fire compartmentation uses)		
E:	30	
EI1:	NPD	
EI2:	30	
EW:	NPD	
Smoke control	SA	
Ability to release	Released	
Self-closing	C	
Durability of ability to release	NPD	
Durability of self-closing		
Against degradation (cycle testing): Against ageing (corrosion):		
BM Trada (UK) (Notified Body 1124) issued a certificate of constancy of performance and carried out type testing and calculation Intended use: Communication in domestic and commercial locations; fire, smoke and security compartmentation and/or escape routes For details of handling, installation and maintenance see 'FPP-IM-STDR-501-A' Please see product declaration of performance.		

4.4 Labelling for Fire and Security Certification

 Labelling for Fire and Security certification should be carried out in accordance with the certification schemes requirements.

4.5 Reference Tables

 The following table notes the approved hardware, and the required intumescent protection for each item.

Hardware			Intumescent Protection		
Type	Manufacturer	Product	Manufacturer	Product	Location
Hinges	Zoo	ZHSS243RS	Sealed Tight Solutions	1mm Raw Graphite	Both hinge blades bedded onto a minimum of one layer of gasket
	Royde and Tucker	H207			
Locks	ERA	Surefire Classic	Sealed Tight Solutions	1mm ERA Surefire Intumescent Kit	Central, top and bottom lockcases fitted with pre-cut gaskets and top and bottom keeps fitted with pre-cut gaskets
Handle	ERA	1X000	Not required		
	Stanza	ZPZ090SC	Not required		
Cylinder	ERA	Fortress 3* Thumbturn	Not required		
Surface Mounted Closer	Hoppe	AR1500	Not required		
	DormaKaba	TS93	Not required		
Jamb Mounted Closer	Astra	4003	Sealed Tight Solutions	1mm Raw Graphite	Intumescent gasket to line the cut out
Letterplates	ERA Fab&Fix	Numail with security cowl	Sealed Tight Solutions	2x40mm Graphite	Fitted lining the letterplate aperture- 2mm intumescent to be wrapped twice around the letterplate channel
Eye Viewer	Sealed Tight Solutions	4008	Sealed Tight Solutions	1mm Raw Graphite	Wrapped around the eye viewer body
	ERA Fab&Fix	Spyhole	Not required		
Door Knocker	ERA	Ingot	Not required		
Security Chain	ERA	PVCu/Timber Door Chain 791-65	Not required		
Numerals	ERA Fab&Fix	Door numerals FFNUM8BC	Not required		

 The following table notes the approved weather/smoke seal options. Seals from differing options cannot be mixed.

Option	Manufacturer	Type	Product	Dimensions	Location
1	Norseal Ltd	Smoke/weather seal	NOR710	11x10mm	Self-adhered in the corner of the stop and the frame reveal
		Dropseal	NOR810S	12x20mm	Centrally rebated into the bottom edge of the leaf and screwed with 3no 20mm wood screws
2	Sealed Tight Solutions Ltd	Smoke/weather seal	ST1009	10x9mm	Self-adhered in the corner of the stop and the frame reveal
		Dropseal	ST422	12x20mm	Centrally rebated into the bottom edge of the leaf and screwed with 3no 20mm wood screws

 The following table notes the approved glazing system options. Seals from differing options cannot be mixed.

Classification	Manufacturer	Glazing Tape	Glazing Liner
E30 Fire	Sealmaster Ltd	10x4mm Black Glazing Tape (BGT)	N/A
EI30 Fire, EI30 Smoke	Sealed Tight Solutions Ltd	9x3mm ST105-3	2x15mm ST302

For technical support, training and guidance

Falcon Panel Products Ltd

Door Technical Office

Unit 1 Block 2
Birch House Business Centre
Hen Lon Parcwr
Ruthin
Denbighshire
LL15 1NA

t: 01824 730266

e: doortechnical@falconpp.co.uk

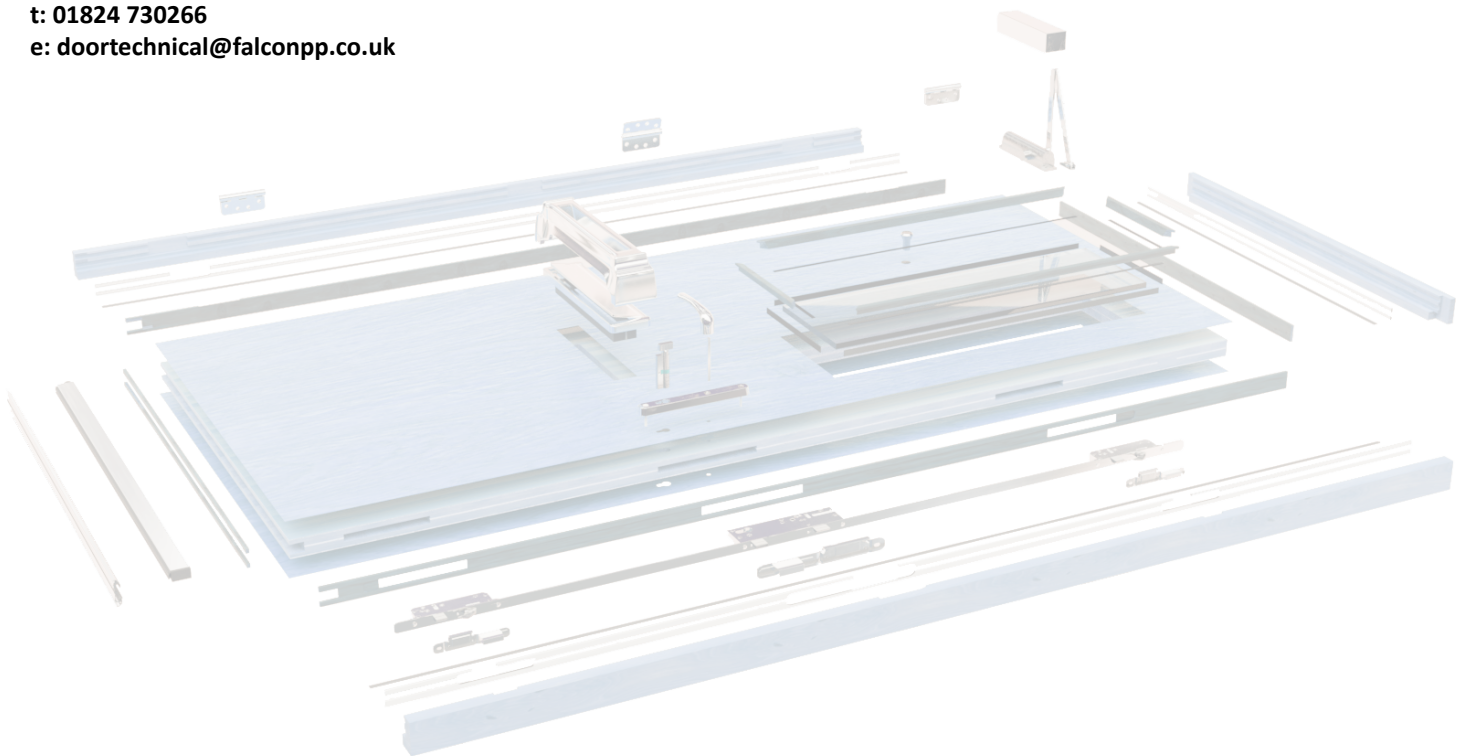

All product names, trademark and registered trademarks are property of their respective owners and are used in this document for the purpose of identification only.



Gateshead Depot	T 0191 338 8208	E gateshead@falconpp.co.uk
Haydock Depot	T 01744 416 600	E haydock@falconpp.co.uk
High Wycombe Depot	T 01494 291 777	E highwycombe@falconpp.co.uk
Leeds Depot	T 0113 887 2222	E leeds@falconpp.co.uk
Nottingham Depot	T 0115 919 2000	E nottingham@falconpp.co.uk
Tilbury Depot	T 01375 487 300	E tilbury@falconpp.co.uk
West Bromwich Depot	T 0121 525 8844	E westbrom@falconpp.co.uk

Falcon Panel Products Ltd
Clock House
Station Approach
Shepperton, Middlesex
TW17 8AN
E sales@falconpp.co.uk

www.falconpp.co.uk