



INTERNATIONAL FIRE
CONSULTANTS LIMITED

PRIVATE & CONFIDENTIAL

IFC FIELD OF APPLICATION REPORT

Field of Application for FD60 and FD90 Ramkor 90 and 90 Plus Timber Door Leaves Installed in Timber Frames

Fire Resistance Standard: BS476: Part 22: 1987

IFC Report PAR/17082/01

Prepared on behalf of: Ramkor International Ltd
OMC Chambers
PO Box 3152
Road Town, Tortola
British Virgin Islands

NOTE: This report should not be manipulated, abridged or otherwise presented without the written consent of International Fire Consultants Ltd

Issue Date – July 2017
Valid Until – July 2022

ISSUE AND AMENDMENT RECORD

Rev	Date	Author	Review	Section	Amendments
Draft	June 2017	CS/WL	DC	-	-
PAR/17082/01	July	CS/WL	DC	-	-

CONTENTS

1. INTRODUCTION.....	5
2. TEST EVIDENCE	5
3. SCOPE OF APPROVAL	5
3.1 DOOR ASSEMBLY CONFIGURATION	5
3.2 MAXIMUM ASSESSABLE DOOR LEAF SIZES	6
3.3 DOOR LEAF SPECIFICATION	6
3.4 FRAMES	9
3.5 GLAZED APERTURES	10
3.6 HARDWARE	11
3.7 INSTALLATION, SUPPORTING CONSTRUCTION AND DOOR EDGE GAPS	11
3.8 INTUMESCENT SEALS	12
3.9 AMBIENT TEMPERATURE SMOKE SEALS.....	13
4. CONCLUSION.....	13
5. DECLARATION BY THE APPLICANT	14
6. LIMITATIONS	15
7. VALIDITY	17
APPENDIX A	18
FIGURES PAR/17082/01:A01 TO A02 CONSTRUCTION DETAILS	
APPENDIX B	19
ASSESSED INTUMESCENT SEAL SPECIFICATIONS FOR RAMKOR 90 DOOR LEAVES INSTALLED IN TIMBER FRAMES	
APPENDIX C	20
ASSESSED INTUMESCENT SEAL SPECIFICATIONS FOR RAMKOR 90 PLUS DOOR LEAVES INSTALLED IN TIMBER FRAMES	
APPENDIX D	21
FIGURES PAR/17082/01:D01 ASSESSED LEAF SIZE ENVELOPES FOR RAMKOR 90 DOOR CORE FOR 60 MINUTES	
APPENDIX E	22
FIGURES PAR/17082/01:E01 ASSESSED LEAF SIZE ENVELOPES FOR RAMKOR 90 DOOR CORE FOR 90 MINUTES	

APPENDIX F	23
FIGURES PAR/17082/01:F01	
ASSESSED LEAF SIZE ENVELOPES FOR RAMKOR 90 PLUS DOOR CORE FOR 60 MINUTES	
APPENDIX G	24
FIGURES PAR/17082/01:G01	
ASSESSED LEAF SIZE ENVELOPES FOR RAMKOR 90 PLUS DOOR CORE FOR 90 MINUTES	
APPENDIX H	25
GENERAL GUIDANCE ON INSTALLATION OF HARDWARE	
APPENDIX I	28
SUMMARY OF FIRE TEST EVIDENCE	

1. INTRODUCTION

This report has been prepared by International Fire Consultants Ltd (IFC), on the instruction of Ramkor International Ltd, to define the field of application for timber based door assemblies, comprising timber door leaves installed in timber frames, that are required to provide 60 and 90 minute fire resistance performance, when adjudged against BS476: Part 22: 1987.

The methodologies used in preparing this document are based upon the guidance in BS ISO/TR 12470: 1998; *'Fire resistance tests - Guidance on the application and extension of results'*.

It is proposed that variations to the tested specifications, as described in the following sections, may be accommodated into assemblies, without reducing their potential to achieve a 60 or 90 minute integrity rating, if tested in accordance with the method and criteria of BS476: Part 22: 1987. The omission of information on any components or manufacturing methods does not imply a lack of approval of those details but these would need to be the subject of a separate analysis. Only variations specifically mentioned are supported by this assessment document, and all other aspects must otherwise be as proven in tests summarised herein.

2. TEST EVIDENCE

The test evidence used to support this Field of Application Report is summarised in Appendix I of this report.

3. SCOPE OF APPROVAL

3.1 Door Assembly Configuration

The approved leaf sizes and configurations of door assemblies comprising timber door leaves are outlined below:

Envelope of Approved Leaf Size - Door Configurations for 60 Minutes

Configuration	90 Door Core,	90 Plus Door Core,
 <ul style="list-style-type: none"> ● Latched ● Single Acting ● Single Door ● Without Overpanel 	<p>Figure PAR/17082/01:D01 in Appendix D</p>	<p>Figure PAR/17082/01:F01 in Appendix F</p>

Envelope of Approved Leaf Size - Door Configurations for 90 Minutes

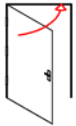
Configuration	90 Door Core,	90 Plus Door Core,
 <ul style="list-style-type: none"> ● Latched ● Single Acting ● Single Door ● Without Overpanel 	<p>Figure PAR/17082/01:E01 in Appendix E</p>	<p>Figure PAR/17082/01:G01 in Appendix G</p>

3.2 Maximum Assessable Door Leaf Sizes

The calculated envelopes of assessed leaf dimensions for each door assembly configuration covered by this field of application report are given in Appendices D to G, based upon use of the intumescent seal specifications shown in Appendix B and C.

3.3 Door Leaf Specification

The Ramkor FD90 and FD90 Plus door leaves, for both 90 and 60 minute applications, comprise a particleboard construction, with details of the constructional specifications given below.

The leaf constructions, below, are based upon the test evidence detailed in Appendix I, and define variations and tolerances, where it is considered that these will not adversely affect overall fire resistance. The construction details are limited to the information available from the test reports.

3.3.1 Ramkor 90 Door Blank

Component		Material	Density	Dimensions
Core		Ramkor Particleboard	590kg/m ³ <i>Note 1 & 2</i>	48mm thick
Facings		Ramkor Particleboard		8mm thick
Square edged lippings <i>Note 3</i>	Exposed intumescent specification	Hardwood	640kg/m ³ <i>Note 4</i>	8–10mm thick
	Concealed intumescent specification			5mm thick <i>Note 5</i>
Adhesive	Lippings	Polyurethane	–	–
	Core	Details held on confidential file	–	–
Minimum leaf thickness		–	–	64mm
Optional additional decorative finishes		Timber veneer or decorative plastic based laminate (to leaf faces only)	–	Maximum 2mm thick
		Paint or varnish	–	Maximum 0.5mm thick

3.3.2 Ramkor 90 Plus Door Blank

Component		Material	Density	Dimensions
Core		Ramkor Particleboard <i>Note 6 & 7</i>	490kg/m ³ <i>Note 2</i>	64mm thick
Lippings <i>Note 3</i>	Square edges	Hardwood	640kg/m ³ <i>Note 4</i>	8–10mm thick
Adhesive	Lippings	Polyurethane	–	–
Minimum leaf thickness		–	–	64mm
Optional additional decorative finishes		Timber veneer or decorative plastic based laminate (to leaf faces only)	–	Maximum 2mm thick
		Paint or varnish	–	Maximum 0.5mm thick

Note 1 Average density of the pre-bonded sandwich comprising the core and facings.

Note 2 Average density with a $\pm 10\%$ variation permissible.

Note 3 Lippings to be installed to all four edges.

Note 4 Lippings to be straight grained hardwood, with minimum measured density at 12% moisture content and of appropriate quality in accordance with BS EN 942: 2007. Moisture content to be $10 \pm 2\%$ for UK market (or to suit internal joinery moisture content specification of export countries).

The machining of the core/lipping, and bonding process, must be such to ensure that no gaps occur between core and lipping.

Note 5 Lippings of 5mm must be fitted with the intumescent concealed in the rear of the lippings. See Appendix B for concealed intumescent specification.

Note 6 To achieve wider leaf sizes the Ramkor 90 plus core may incorporate a full height extension fixed via a joint in the core, as shown in Figure PAR/17082/01:A01 in Appendix A. The joint is to be no more than 160mm from the hanging edge of the leaf, and to be fixed using a non-thermally softening adhesive. Overall leaf sizes must still remain within those defined in this report.

Note 7 To achieve a greater height in leaf size the Ramkor 90 plus core may incorporate a full width extension fixed via a joint in the core, at the base of the leaf, as shown in Figure PAR/17082/01:A01 in Appendix A. The joint is to be no more than 160mm from the bottom edge of the leaf, and to be fixed using a non-thermally softening adhesive. Overall leaf sizes must still remain within those defined in this report.

3.4 Frames

Timber frames, to the specifications given below, may be used across the complete range of approved sizes and configurations outlined in Appendices D to G, utilising the intumescent seal specification outlined in Appendix B and C.

Material	Density	Minimum Face Width	Minimum Frame Depth	Minimum Stop Depth
		Single Acting		
Hardwood	640kg/m ³ <i>Note 8</i>	45mm, excluding stop <i>Note 9</i>	100mm <i>Note 10</i>	24mm <i>Note 11</i>

Note 8 Timber must have a minimum measured density at 12% moisture content. The timber must be straight grained and of appropriate quality in accordance with BS EN 942: 1996. The moisture content shall be 10 ± 2% for UK market, (or to suit internal joinery moisture content specification of export countries).

Note 9 These dimensions assume that the rear of the frame is protected by the adjacent wall, (and firestopping), and that the frame does not project out from the wall. See Section 3.6 regarding projecting frames and shadow gaps.

Note 10 In assemblies where Pyroplex expanding foam is used to fill the cavity between the rear of the frame and the supporting construction the frame depth must be a minimum of 140mm.

Note 11 The door stop is to comprise the same material as the door frame and may be either planted and pinned using 40mm steel pins, or integral with the main door frame, providing the minimum frame thickness remains as stated.

The overall frame depth may be increased by the use of extension linings, but the joint between the main frame and the extension lining must not intrude in the plane of the door thickness.

Head/jamb joint : Mortice and tenon, or half-lapped joint, head twice screwed to each jamb **or** mitred joint which is glued with a non-thermally softening adhesive and the head twice screwed to each jamb.

Architraves : Where the face of the frame, and the door, are flush with the face of the wall, loose architraves are optional, and have no fire performance requirements, and so can be freely specified, subject to adequate fire stopping. (See Section 3.7 regarding wall/frame gaps). Where fire rated foam has been used, an intimately fitted hardwood architrave with a minimum density of 640kg/m³ and minimum dimensions of 50mm wide x 10mm thick.

3.5 Glazed Apertures

3.5.1 Glass types

The following glass types are approved for use in the doors considered, herein, which are compatible with the identified approved glazing systems given in Section 3.5.2, although some restrictions on size may be given in subsequent sections. See also Section 3.5.6 regarding ladder glazing.

The codes used, below, for the glass types, glazing materials, and bead types, (e.g. G1, S1 and B1), are not those used by the respective manufactures, and are attributed solely by IFC for the purpose of identification and cross-referencing within this assessment.

G1 9mm thick Firelite (Southern Ceramics)

Expansion allowances for all glass types shall be as recommended by the glass manufacturer.

3.5.2 Glazing materials and systems

The following glazing materials are approved for use in the doors considered, herein, which are compatible with the identified approved glass types listed above, although some restrictions on size may be given in subsequent sections. (See also **Figure PAR/17082/01:A02** in Appendix A for limitations).

S1 5mm thick Sealmaster FG liner glazing tape and ISL 60 Plus 65 x 2mm aperture liner.

3.5.3 Bead profiles and installation

The approved bead sizes and profiles, and relevant fixing details, are shown on the **Figures PAR/17082/01:A02** in Appendix A, which also define any limitations upon options of interchangeability with glass types, glazing systems and bead profiles.

B1 Ramglaze 90™, 1.5mm thick galvanised steel glazing bead profile.

3.5.4 Assessed aperture sizes

Apertures are created by cutting directly into the door slab, with beads fitted directly to the particleboard 'core'.

Based upon the size of apertures tested, it is the opinion of IFC that the following limitations apply to glazed apertures in the door leaves considered herein;

	90 minutes	60 minutes
Maximum area of aperture	- 0.23m ²	0.29m ²
Maximum vertical length of aperture	- 915	1175
Maximum horizontal length of aperture	- 285	365
Minimum distance from leaf edge (side)	- 230	180
Minimum distance from leaf edge (top)	- 230	180
Minimum distance from leaf edge (bottom)	- 250	250

3.6 Hardware

Some of the various items of hardware to be used with the proposed door assemblies will have a positive contribution to the overall performance ('essential hardware') and others are classed as 'non-essential'. However, in all cases it must be ensured that choice of items, or their installation within the assemblies, does not have a detrimental effect upon their achievement of the required period of fire resistance.

General guidance for all items of hardware is outlined in Appendix H, based upon the range of items tested. All hardware beyond the scope of the general guidance must have been subjected to fire resistance testing, and/or assessed by a notified body to support its use in doors of a similar construction to that proposed.

3.7 Installation, Supporting Construction and Door Edge Gaps

The frames must be fixed back to the supporting construction with steel fixings at centres not exceeding 600mm on the vertical edges (minimum 200mm from the top and bottom). Screws shall be of sufficient length to penetrate the wall by at least 40mm, and shall be positioned such that they are not exploited by charring of the frame, irrespective of the direction of test exposure; (this may necessitate a twin line of screws). Packers shall be used at all fixing positions, although if combustible packers are employed, these must be protected by a layer of gap sealing (see below) aligned near to each face of the door frame.

The supporting construction may be blockwork, brickwork or concrete walls, but shall be of a type that has been tested or assessed to provide in excess of 60 or 90 minutes fire resistance, as required, at the required size, when incorporating door openings. If fitted into timber or steel stud partitions, the method of forming the door assembly aperture must be as tested by the partition and/or door assembly manufacturer.

No part of the rear of the frame section shall be exposed once installed and leaves must not project beyond the exposed face of the door frame.

There shall be no feature rebates or shadow gaps at the junction of the frame and wall with timber frames.

When the fire resistance of the door assemblies is to be a minimum of 60 or 90 minutes, the gap sealing between the supporting construction and timber frames should be as tested. For frame depths in excess of 140mm, Pyroplex expanding foam may be used to fill the cavity providing that the gap is not larger than the tested 10mm. The foam must be capped with intumescent mastic and fitted with architraves *Note 12*. Alternatively, the gap sealing between the supporting construction and timber frame should be filled with tightly packed mineral rock fibre for the fill depth of the frame and capped with intumescent mastic.

Note 12 See Section 3.4 regarding architrave requirements for differing fire stopping.

When the fire resistance of the door assemblies are to be a minimum of 60 minutes, the gap sealing between the supporting construction and timber frames may follow the recommendations of Tables 4 and 5 in BS8214: 2016, '*Timber-based fire door assemblies – Code of practice*', using a product proven in such timber applications.

Other tested, assessed or Third Party Certificated solutions for gap sealing may also be utilised using a product proven in such timber applications, and with reference to the correct depth of seal to suit the width of gap between wall and frame for the required period of fire resistance.

Gap sealing shall be positioned on the plane of the door leaf (unless combustible packers are employed).

The gap between the door and the frame should be 1.5–4mm. Gaps under the door(s) shall not exceed 6mm for fire performance, although, if smoke control is also required, these gaps shall only be 3mm, or smoke seals shall be included (see also Section 3.8 regarding suitability of smoke seals).

The door assembly design shall be such that when closed single acting leaves are fully flush within the frame.

3.8 Intumescent Seals

The intumescent seal specifications, widths, and positions are shown in Appendix B and C, based upon tested details.

It is recommended that the intumescent seals are manufactured or supplied by members of the Intumescent Seals Association (IFSA) or that the product is included in a Third Party Certification scheme, such as that provided by IFC Certification, to ensure product quality and consistency.

Intumescent protection is required for specific items of building hardware and this has been detailed in Appendix H based upon details tested.

3.9 Ambient Temperature Smoke Seals

Smoke seals, or combined intumescent/smoke seals (using the specification approved in Section 3.7), that have been tested in accordance with BS EN 1634-3: 2004 (ambient temperature) or BS476: Part 31: Section 31.1: 1983 and shown not to leak by more than 3m³/m/hr at 25Pa may be used in conjunction with the proposed door assemblies to provide smoke control.

The orientation of the seals, door edge gaps, degree of hardware interruption, and leaf configuration, will need to be as tested in accordance with BS EN 1634-3: 2004 (ambient temperature) or BS476: Part 31: Section 31.1: 1983 to achieve the desired level of smoke control, unless these conflict with the intumescent seal widths and positions as described in Appendix B and C, in which case, the latter shall take precedence.

Test evidence to BS476: Part 22: 1987 shall be available to demonstrate that the smoke seals will not adversely affect the overall fire resistance of timber door assemblies, when fitted in the proposed arrangements.

4. CONCLUSION

It is the opinion of International Fire Consultants Ltd that if the proposed door assemblies utilising Ramkor 90 and 90 Plus timber door leaves installed in timber frames were manufactured and installed within the limitations of this Field of Application Report and tested for fire resistance, they would satisfy the integrity criteria of BS476: Part 22: 1987 for 60 or 90 minutes.

5. DECLARATION BY THE APPLICANT

We the undersigned, confirm that, except for that information declared to International Fire Consultants Ltd previously during the original engineering evaluation process, the components, products, and/or assemblies evaluated within IFC Field of Application Report PAR/17082/01 have not been altered in any way; and have not subsequently, to our knowledge, been included in a fire test BS 476: Part 22: 1987 in the form and/or configurations proposed.

We also confirm that we have supplied all information and assurances requested of us, for the purpose of writing this Field of Application Report, and are not aware of any other information that would adversely influence or affect the conclusions of this report.

We agree that if fire test evidence or other information subsequently becomes available, to supply this to IFC in full and seek immediate review of the continuing validity of the original report from IFC. If after review IFC conclude that the original evaluation and report is no longer appropriate, we agree to withdraw it and any references to it from circulation and advise clients and agents accordingly.

Signature:

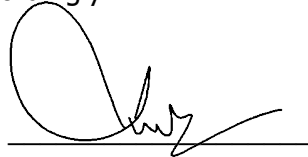
A handwritten signature in black ink, consisting of a large, stylized 'O' followed by a series of loops and a long horizontal stroke extending to the right.

Position:

Managing Director

Company:

Ramkor International Ltd

6. LIMITATIONS

This report addresses itself solely to the ability of the proposed assemblies described to satisfy the criteria of the fire resistance test and does not imply any suitability for use with respect to other unspecified criteria.

This document only considers the door assemblies described, herein, and assumes that the surrounding construction will provide no less restraint than the tested assembly and that it will remain in place and be substantially intact for the full fire resistance period.

Where the constructional information in this report is taken from details provided to International Fire Consultants Ltd (IFC) and/or from fire resistance test reports referenced herein, it is, therefore, limited to the information given in those documents. It is necessarily dependent upon the accuracy and completeness of that information. Where constructional or manufacturing details are not specified, or discussed, herein, it should not, therefore, be taken to infer approval of variation in such details from those tested or otherwise approved.

The analysis and conclusions within this report are based upon the likely fire resisting performance of a complete door assembly that is manufactured and installed in accordance with this document, and offered for fire resistance testing in 'perfect' condition. In practice, management procedures must be in place in any building where the door assemblies are installed, to ensure that no parts of the assembly are damaged or faulty. Further, the doors must open and close without the use of undue force. The edge gaps/alignment of door leaves must be in accordance with the tolerances defined, herein, when the doors are closed. Any such shortfalls in respect to the condition of the assemblies will invalidate the approval by IFC, and may seriously affect the ability of the assemblies to provide the required level of fire resistance performance. Determination of what constitutes wear or damage, and any corrective actions in order to return assemblies to the required condition, should only be carried out following consultation with the manufacturer and IFC.

This report applies to fire door assemblies that are evaluated to BS476: Part 22: 1987; which is an applicable test method currently referenced within guidance to Building Regulations in the United Kingdom, and in building codes in some other countries. However, IFC have a duty of care to advise that introduction of CE Marking may become compulsory for fire doorsets marketed in the EU, during the validity period of this report; in which case, users should contact IFC for further details/advice.

Where the assessed constructions have not been subject to an on-site audit by International Fire Consultants Ltd, it is the responsibility of anyone using this report to confirm that all aspects of the assemblies fully comply with the descriptions and limitations, herein.

Any materials specified in this report have been selected and judged primarily on their fire performance. IFC do not claim expertise in areas other than fire safety. Whilst observing all possible care in the specification of solutions, we would draw the reader's attention to the fact that during the construction and procurement process, the materials used should be subjected to more general examination regarding the wider Health and Safety, and CoSHH Regulations.

This assessment considers the fire resistance performance of the door assemblies when tested with the leaves in the closed position, within the frame reveal; either retained by the latch, or self-closing device, or locked shut, as applicable. The door assemblies will only provide the assessed fire performance when in a similar configuration; and it is the responsibility of the building occupants/owner to ensure that this is the case.

This Report is provided to the sponsor on the basis that it is a professional independent engineering opinion as to what the fire performance of the construction/system would be should it to be tested to the named standard. It is IFC's experience that such an opinion is normally acceptable in support of an application for building approvals, certainly throughout the UK and in many parts of Europe and the rest of the world.

However, unless IFC have been commissioned to liaise with the Authorities that have jurisdiction for the building in question for the purpose of obtaining the necessary approvals, IFC cannot assure that the document will satisfy the requirements of the particular building regulations for any building being constructed.

It is, therefore, the responsibility of the sponsor to establish whether this evidence is appropriate for the application for which it is being supplied and IFC cannot take responsibility for any costs incurred as a result of any rejection of the document for reasons outside of our control. Early submittal of the Report to the Authorities will minimise any risks in this respect.

7. VALIDITY

This Field of Application Report has been prepared based on International Fire Consultants Ltd's present knowledge of the products described, the stated testing regime and the submitted test evidence. For this reason, anyone using this document after July 2022 should confirm its ongoing validity.

Prepared by:



Callum Sempill BSc (Hons)
Fire Safety Engineer
International Fire Consultants Ltd (IFC)

and:



Will Lightfoot BEng (Hons), AIFireE
Fire Safety Engineer
International Fire Consultants Ltd (IFC)

Reviewed by:



David Cooper BEng (Hons) AIMMM AIFireE
Fire Safety Engineering Manager
International Fire Consultants Ltd. (IFC)

APPENDIX A

Figures PAR/17082/01:A01 to A02

Construction Details

***The figures in this Appendix are not included
in the sequential page numbering of this report***

Hanging Edge Detail

Jointed Core

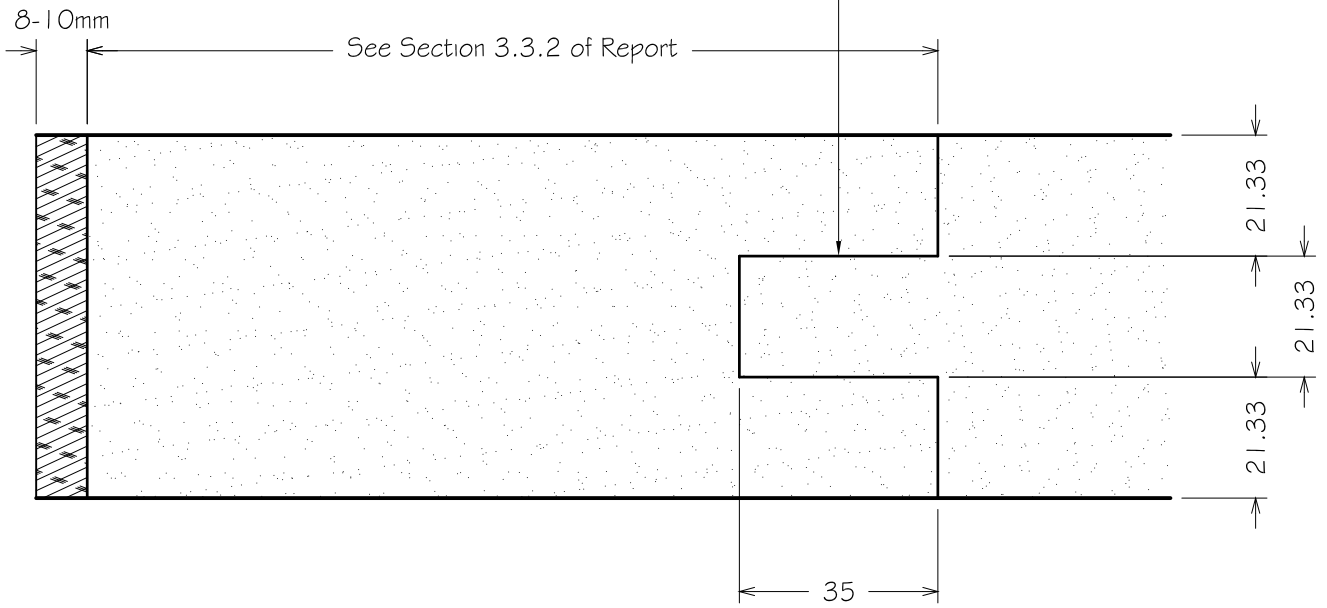

Threshold Detail

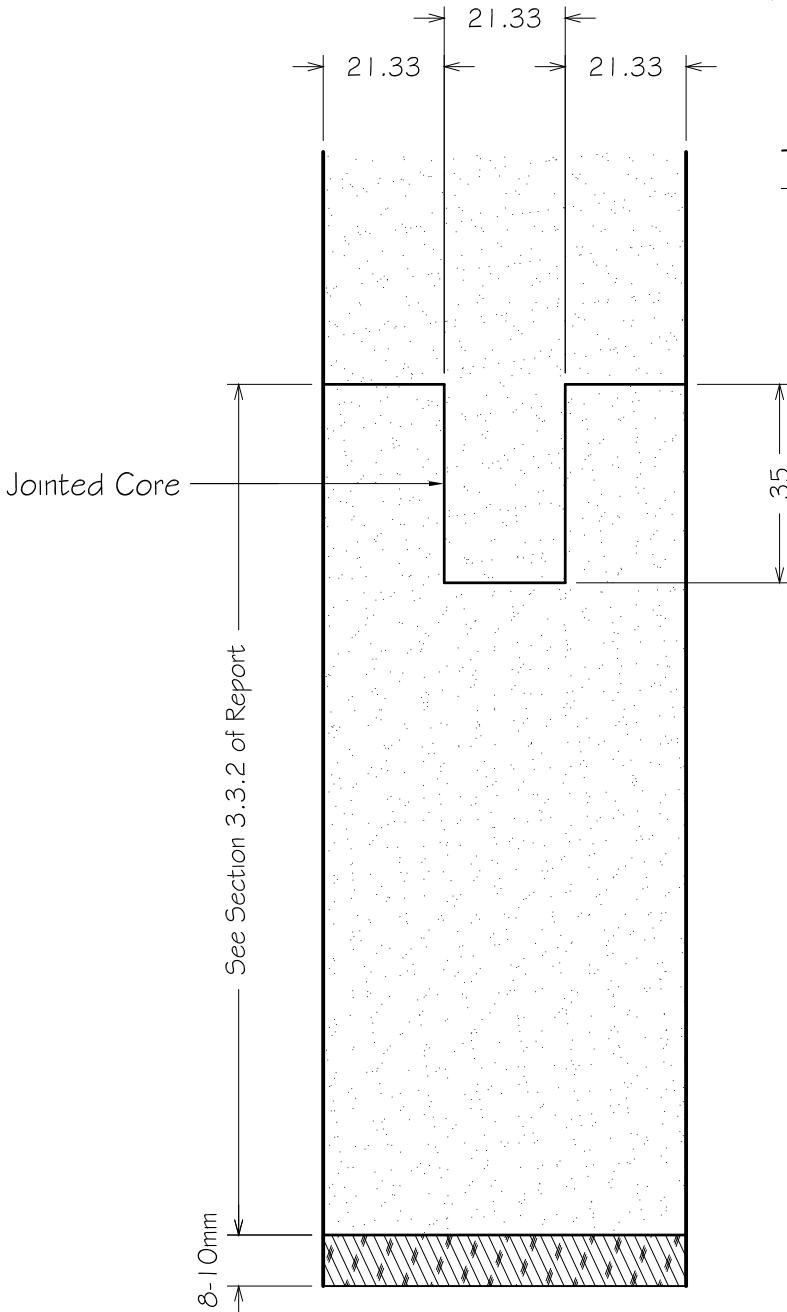

This drawing is Copyright©
Contractors must check all dimensions.
Any discrepancies must be reported before
work proceeds.
Only work to dimensions stated on drawing.

**INTERNATIONAL FIRE
CONSULTANTS LIMITED**

20 Park Street
PRINCES RISBOROUGH
Buckinghamshire
HP27 9AH
United Kingdom
Tel: +44 (0)1844 275500
Fax: +44 (0)1844 274002
Email: info@ifcgroup.com
Web: www.ifcgroup.com

Field of Application Report
PAR/17082/01
Ramkor International Ltd
FD60 & FD90 Ramkor 90 & 90 Plus Timber
Door Leaves Installed in Timber Frames

Ramkor 90 Plus
Core Joint Detail

Job number: 17082
Drawn by: CSP Checked by: WL
Not To Scale Drawn: Jun 2017

PAR/17082/01:AO1

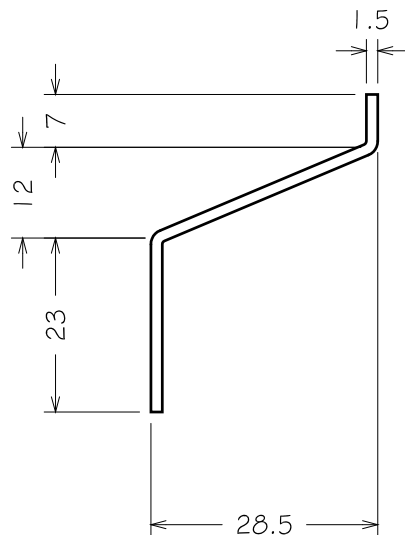
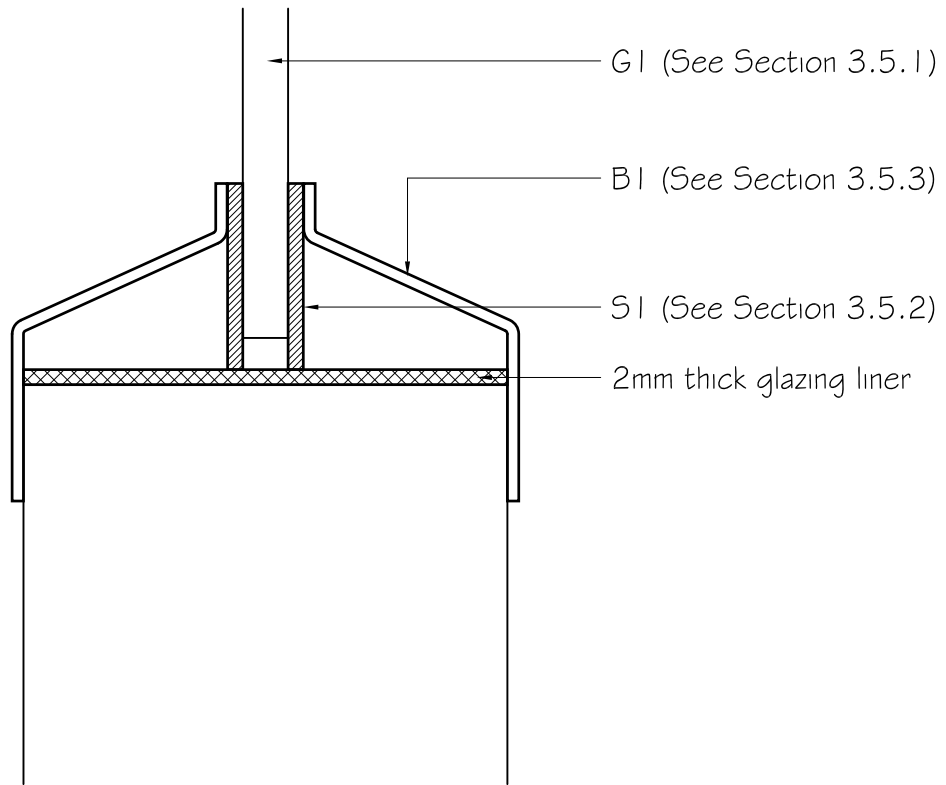

This drawing is Copyright©
 Contractors must check all dimensions.
 Any discrepancies must be reported before
 work proceeds.
 Only work to dimensions stated on drawing.

**INTERNATIONAL FIRE
CONSULTANTS LIMITED**

20 Park Street
 PRINCES RISBOROUGH
 Buckinghamshire
 HP27 9AH
 United Kingdom
 Tel: +44 (0)1844 275500
 Fax: +44 (0)1844 274002
 Email: info@ifcgroup.com
 Web: www.ifcgroup.com

Field of Application Report
 PAR/17082/01
 Ramkor International Ltd
 FD60 & FD90 Ramkor 90 & 90 Plus Timber
 Door Leaves Installed in Timber Frames

Glazing Detail

Job number: 17082

Drawn by: CSP

Checked by: WL

Not To Scale

Drawn: Jun 2017

PAR/17082/01:A02

APPENDIX B

Assessed Intumescent Seal Specifications for Ramkor 90 Door Leaves Installed in Timber Frames

Concealed intumescent specification:

Location	Specification
Frame Reveal	1no 50 x 1mm Intumescent Seals Limited Therm-A-Flex Plus PVC encased seal located centrally to the frame reveal within pre-fabricated recesses in the door leaf
Leaf edge (concealed)	1no 44 x 2mm Palusol® from BASF located centrally behind all lippings, adhered with PUR

or

Exposed intumescent specification:

Location	Specification
Frame reveal	2no 20 x 4mm Pyroplex rigid box seals (Ref: F8600) fitted 10mm apart, centrally to the frame reveal within pre-fabricated recesses in the frame reveal
Leaf edge	Head and hanging edges 1no 15 x 4mm Pyroplex rigid box seal (Ref: F8700) fitted centrally to the leaf edge within pre-fabricated recesses in the leaf
	Threshold 1No 30 x 2mm Pyroplex Graphite (Ref: 30075) fitted centrally in the leaf threshold within pre-fabricated recesses in the leaf

APPENDIX C

Assessed Intumescent Seal Specifications for Ramkor 90 Plus Door Leaves Installed in Timber Frames

Location	Specification
Frame reveal	1no 50 x 2mm Intumescent Seals Limited Therm-A-Flex PVC encased seal located centrally to the frame reveal within pre-fabricated recesses in the frame reveal
Leaf edge	2no 15 x 4mm Intumescent Seals Limited Therm-A-Seal PVC encased seal located centrally to the leaf edge within pre-fabricated recesses in the door leaf

or

Location	Specification
Frame reveal	2no 20 x 4mm Pyroplex rigid box seals (Ref: F8600) fitted 10mm apart, centrally to the frame reveal within pre-fabricated recesses in the frame reveal
Leaf edge	Head and hanging edges 1no 15 x 4mm Pyroplex rigid box seal (Ref: F8700) fitted centrally to the leaf edge within pre-fabricated recesses in the leaf
	Threshold 1no 30 x 2mm Pyroplex Graphite (Ref: 30075) fitted centrally in the leaf threshold within pre-fabricated recesses in the leaf

APPENDIX D

Figures PAR/17082/01:D01

**Assessed Leaf Size Envelopes for
Ramkor 90 Door core for 60
minutes**

***The figure in this Appendix is not included
in the sequential page numbering of this report***

	A	B
Width	854	1094
Height	2670	2189

LEAF SIZE ENVELOPE POINTS

Configuration

Timber Frames

LATCHED
SINGLE ACTING
SINGLE LEAF
WITHOUT OVERPANEL
FD90 CORE

REQUIRED INTEGRITY : 60 Minutes

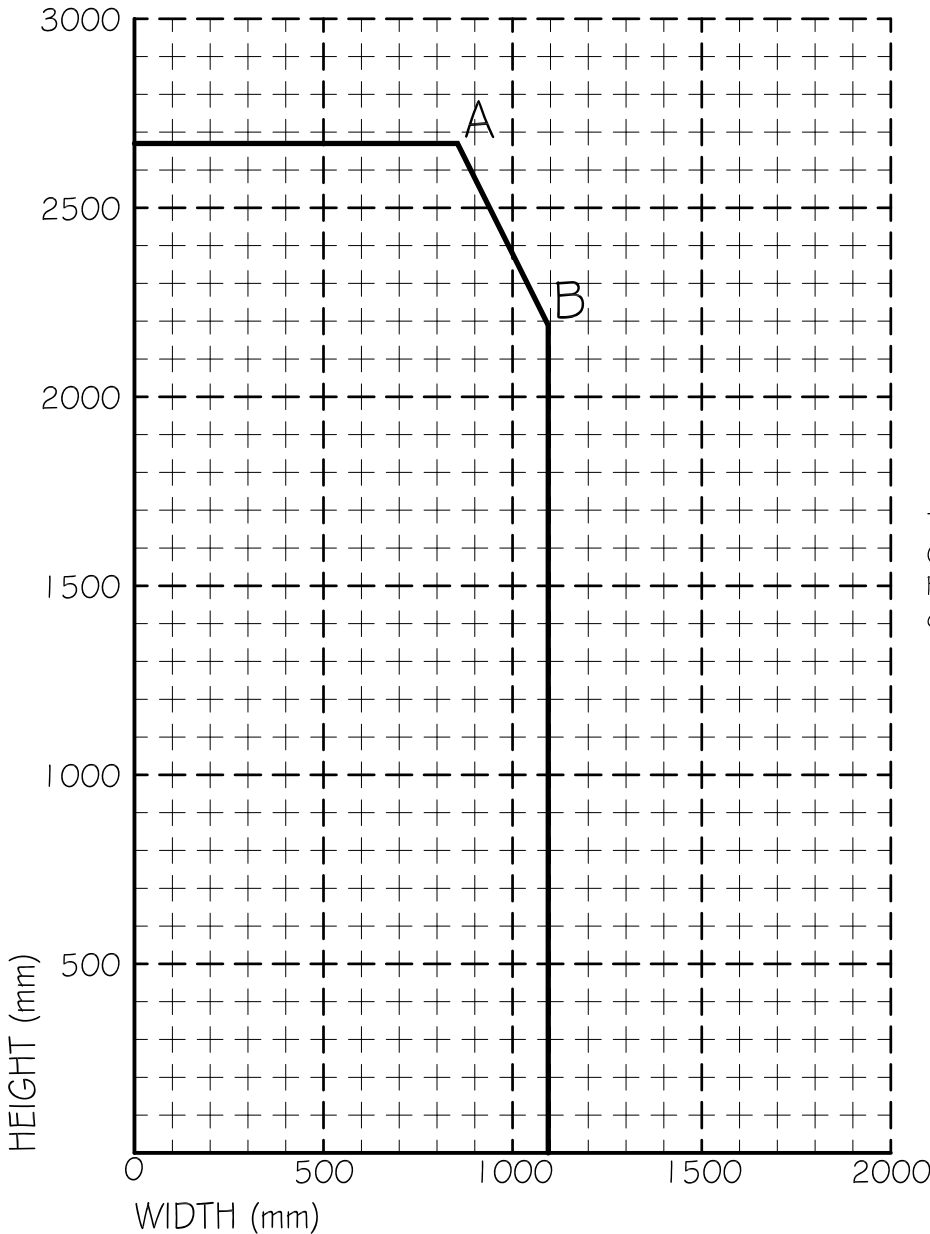

This figure forms part of International Fire Consultants Ltd's Field of Application Report PAR/17082/01, which contains full details of the assessed door construction.

This drawing is Copyright©
Contractors must check all dimensions.
Any discrepancies must be reported before
work proceeds.
Only work to dimensions stated on drawing.

**INTERNATIONAL FIRE
CONSULTANTS LIMITED**

20 Park Street
PRINCES RISBOROUGH
Buckinghamshire
HP27 9AH
United Kingdom
Tel: +44 (0)1844 275500
Fax: +44 (0)1844 274002
Email: info@ifcgroup.com
Web: www.ifcgroup.com

Field of Application Report
PAR/17082/01
Ramkor International Ltd
FD60 & FD90 Ramkor 90 & 90 Plus Timber
Door Leaves Installed in Timber Frames

Envelope of Approved
Door Leaf Sizes
LSASD
In Timber Frames

Job number: 17082

Drawn by: CSP Checked by: WL

Not To Scale Drawn: Jun 2017

PAR/17082/01:DOI

ENVELOPE OF APPROVED LEAF SIZES

The above graph represents the envelope of approved leaf sizes for the proposed door leaf configuration.

Any combination of leaf width and height that falls within the graph axes and the connecting line on the graph above are approved.

POINT A represents the maximum leaf height and its associated width.

POINT B represents the maximum leaf width and its associated height.

APPENDIX E

Figures PAR/17082/01:E01

**Assessed Leaf Size Envelopes for
Ramkor 90 Door core for 90
minutes**

***The figure in this Appendix is not included
in the sequential page numbering of this report***

	A	B
Width	802	1028
Height	2507	2056

LEAF SIZE ENVELOPE POINTS

Configuration

Timber Frames

LATCHED
SINGLE ACTING
SINGLE LEAF
WITHOUT OVERPANEL
FD90 CORE

REQUIRED INTEGRITY : 90 Minutes

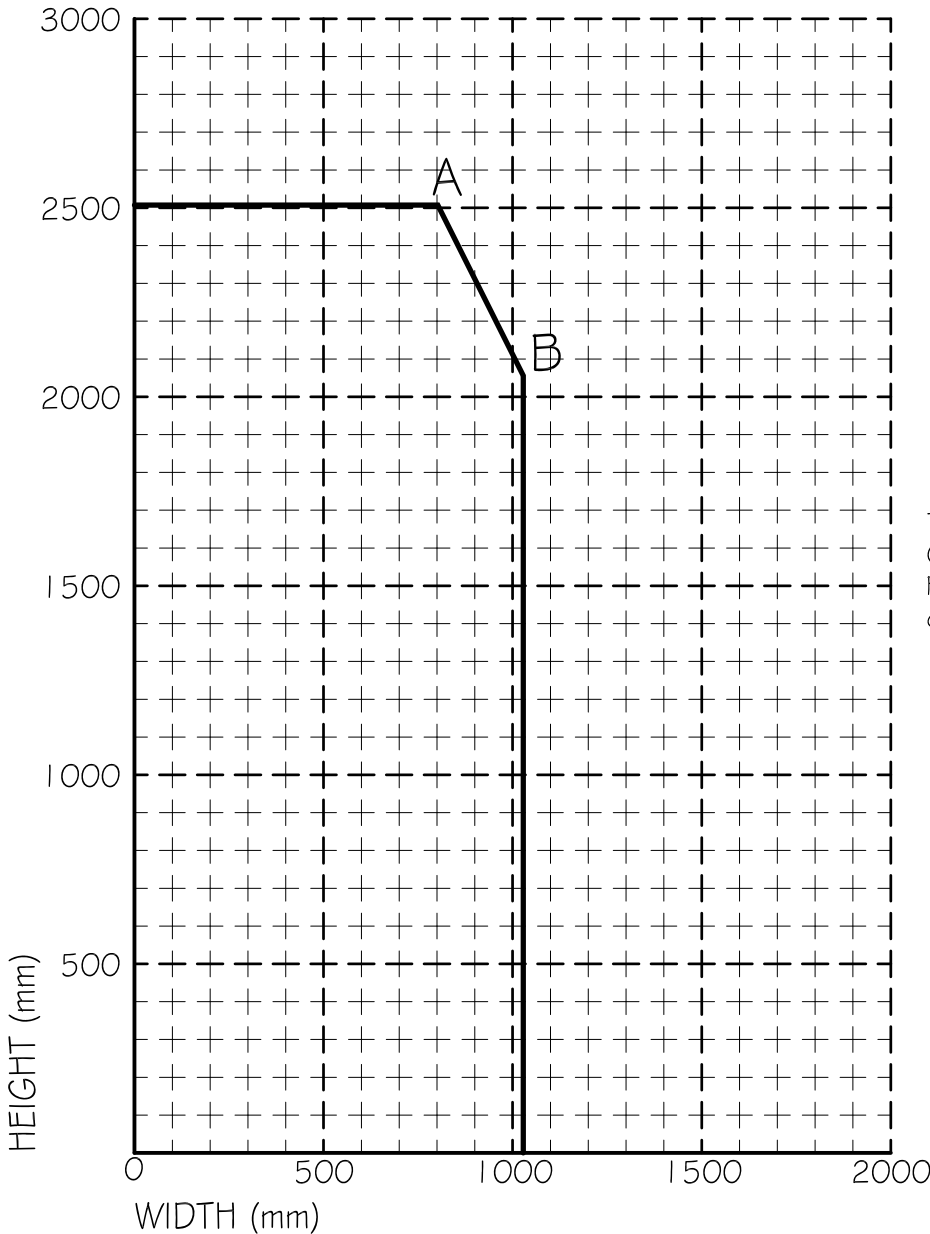

This figure forms part of International Fire Consultants Ltd's Field of Application Report PAR/17082/01, which contains full details of the assessed door construction.

This drawing is Copyright©
Contractors must check all dimensions.
Any discrepancies must be reported before
work proceeds.
Only work to dimensions stated on drawing.

**INTERNATIONAL FIRE
CONSULTANTS LIMITED**

20 Park Street
PRINCES RISBOROUGH
Buckinghamshire
HP27 9AH
United Kingdom
Tel: +44 (0)1844 275500
Fax: +44 (0)1844 274002
Email: info@ifcgroup.com
Web: www.ifcgroup.com

Field of Application Report
PAR/17082/01
Ramkor International Ltd
FD60 & FD90 Ramkor 90 & 90 Plus Timber
Door Leaves Installed in Timber Frames

Envelope of Approved
Door Leaf Sizes
LSASD
In Timber Frames

Job number: 17082

Drawn by: CSP Checked by: WL

Not To Scale Drawn: Jun 2017

PAR/17082/01:EO1

ENVELOPE OF APPROVED LEAF SIZES

The above graph represents the envelope of approved leaf sizes for the proposed door leaf configuration.

Any combination of leaf width and height that falls within the graph axes and the connecting line on the graph above are approved.

POINT A represents the maximum leaf height and its associated width.

POINT B represents the maximum leaf width and its associated height.

APPENDIX F

Figures PAR/17082/01:F01

**Assessed Leaf Size Envelopes for
Ramkor 90 Plus Door core for 60
minutes**

***The figure in this Appendix is not included
in the sequential page numbering of this report***

	A	B
Width	784	1059
Height	2669	2119

LEAF SIZE ENVELOPE POINTS

Configuration

Timber Frames

LATCHED
SINGLE ACTING
SINGLE LEAF
WITHOUT OVERPANEL
FD90 PLUS CORE

REQUIRED INTEGRITY : 60 Minutes

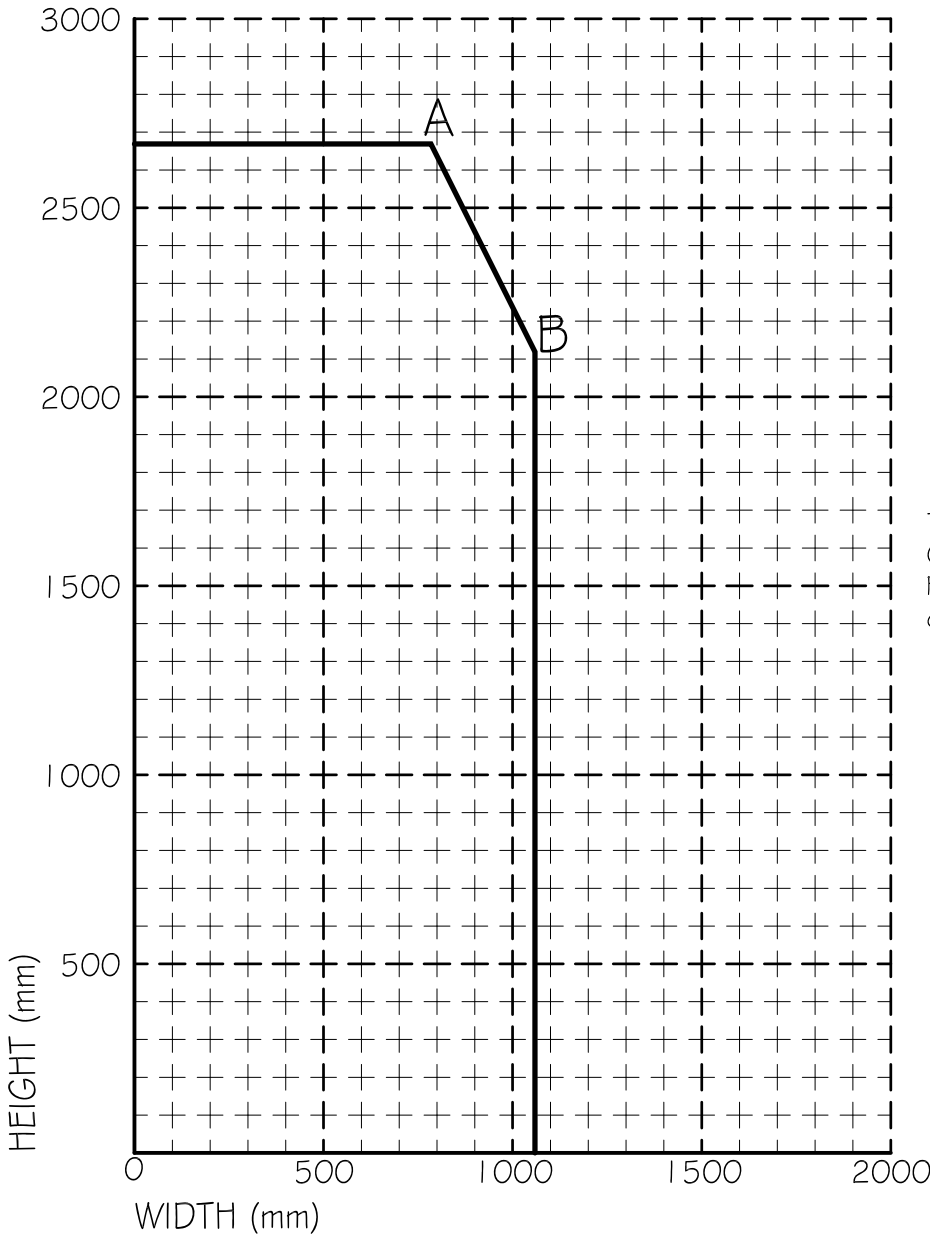

This figure forms part of International Fire Consultants Ltd's Field of Application Report PAR/17082/01, which contains full details of the assessed door construction.

This drawing is Copyright©
Contractors must check all dimensions.
Any discrepancies must be reported before
work proceeds.
Only work to dimensions stated on drawing.

**INTERNATIONAL FIRE
CONSULTANTS LIMITED**

20 Park Street
PRINCES RISBOROUGH
Buckinghamshire
HP27 9AH
United Kingdom
Tel: +44 (0)1844 275500
Fax: +44 (0)1844 274002
Email: info@ifcgroup.com
Web: www.ifcgroup.com

Field of Application Report
PAR/17082/01
Ramkor International Ltd
FD60 & FD90 Ramkor 90 & 90 Plus Timber
Door Leaves Installed in Timber Frames

Envelope of Approved
Door Leaf Sizes
LSASD
In Timber Frames

Job number: 17082

Drawn by: CSP Checked by: WL

Not To Scale Drawn: Jun 2017

PAR/17082/01:FO1

ENVELOPE OF APPROVED LEAF SIZES

The above graph represents the envelope of approved leaf sizes for the proposed door leaf configuration.

Any combination of leaf width and height that falls within the graph axes and the connecting line on the graph above are approved.

POINT A represents the maximum leaf height and its associated width.

POINT B represents the maximum leaf width and its associated height.

APPENDIX G

Figures PAR/17082/01:G01

**Assessed Leaf Size Envelopes for
Ramkor 90 Plus Door core for 90
minutes**

***The figure in this Appendix is not included
in the sequential page numbering of this report***

	A	B
Width	736	995
Height	2506	1990

LEAF SIZE ENVELOPE POINTS

Configuration

Timber Frames

LATCHED
SINGLE ACTING
SINGLE LEAF
WITHOUT OVERPANEL
FD90 PLUS CORE

REQUIRED INTEGRITY : 90 Minutes

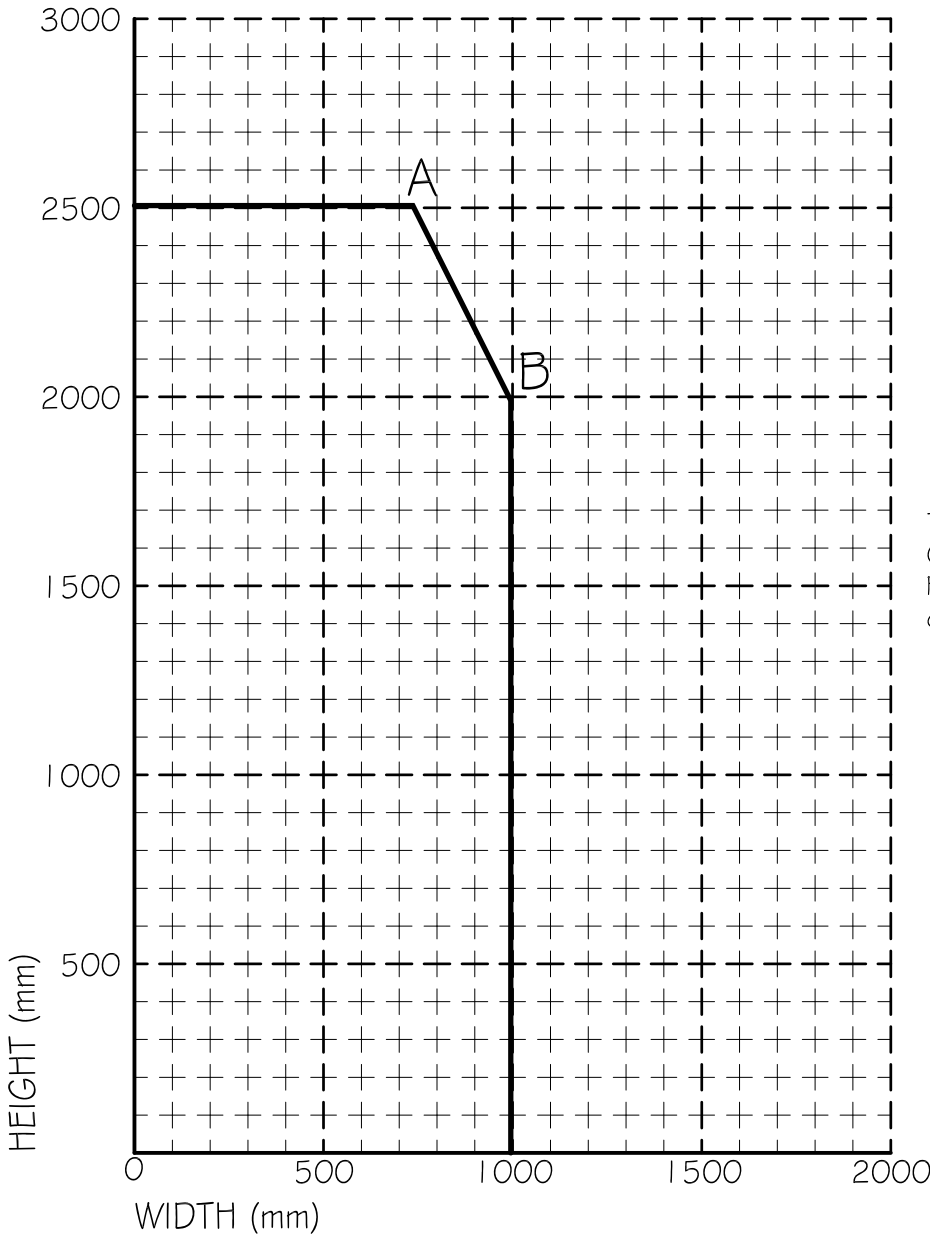

This figure forms part of International Fire Consultants Ltd's Field of Application Report PAR/17082/01, which contains full details of the assessed door construction.

This drawing is Copyright©
Contractors must check all dimensions.
Any discrepancies must be reported before
work proceeds.
Only work to dimensions stated on drawing.

**INTERNATIONAL FIRE
CONSULTANTS LIMITED**

20 Park Street
PRINCES RISBOROUGH
Buckinghamshire
HP27 9AH
United Kingdom
Tel: +44 (0)1844 275500
Fax: +44 (0)1844 274002
Email: info@ifcgroup.com
Web: www.ifcgroup.com

Field of Application Report
PAR/17082/01
Ramkor International Ltd
FD60 & FD90 Ramkor 90 & 90 Plus Timber
Door Leaves Installed in Timber Frames

Envelope of Approved
Door Leaf Sizes
LSASD
In Timber Frames

Job number: 17082

Drawn by: CSP Checked by: WL

Not To Scale Drawn: Jun 2017

PAR/17082/01:G01

ENVELOPE OF APPROVED LEAF SIZES

The above graph represents the envelope of approved leaf sizes for the proposed door leaf configuration.

Any combination of leaf width and height that falls within the graph axes and the connecting line on the graph above are approved.

POINT A represents the maximum leaf height and its associated width.

POINT B represents the maximum leaf width and its associated height.

APPENDIX H

General Guidance on Installation of Hardware

H.1 Hinges

Hinges shall comply with the following specifications:

Hinge types: Fixed pin, washered butt, ball bearing butt, lift-off type or journal supported hinges may be used.

Concealed hinges must be the Laidlaw WJ203BT as tested, that have been included in some of the tests referenced in Appendix I.

Number of hinges: 3no (1½ pairs) per leaf. (4no per leaf should be used on leaves greater than 2300mm high).

Positions: The top hinge must be positioned 150mm down from the head of the leaf to the top of the hinge and the bottom hinge positioned 250mm up from the foot of the leaf to the bottom of the hinge. The middle hinge must be either equispaced between the top and bottom hinge, or 200–250mm below the top hinge. (All positions ±25mm).

Fixings: Steel screws, as recommended by the hinge manufacturers, but in no case smaller than No 8 (3.8mm diameter) by 32mm long, and having thread for the full length. Position of screws (in relation to the door face) in blades of alternative hinge types shall be similar to hinges tested with the proposed door type.

Hinge blade sizes: 2.5–3.5mm thick x 100–110mm high x 102mm width. (These dimensions refer to the total width of the hinge).

Hinge materials: Brass, Phosphor Bronze, Steel or Stainless Steel. (Aluminium, Nylon or 'Mazac' are not permitted). No combustible or thermally softening materials to be included.

Additional protection: The hinge blades must be bedded on non-pressure forming intumescent material at least 1mm thick.

Rising butt, non-cranked butts and spring hinges (single or double action) are not suitable for use on doors approved within the scope of this Field of Application Report.

H.2 Mortice Latches/Locks

Where mortice latches or locks are fitted, they shall be centred at 1000mm (\pm 200mm), above the bottom of the door leaf, and should comply with the following specifications:

Latch/lock types:	Mortice latches, tubular mortice latches, sashlocks, deadlocks
Maximum dimensions:	Forend plate: 235mm long x 20mm wide, or, 200mm long x 25mm wide Latch body: 20mm thick x 165mm high x 100mm wide Strikeplate: 235mm long x 20mm wide, or, 200mm long x 25mm wide
Materials:	Latches must have no essential part of their structure made from polymeric or other low melting point (<800°C) materials, and should not contain any flammable materials.
Additional protection:	The latch body must be encased in and the strikeplate and forend must be bedded on 1mm thick non-pressure forming intumescent material.

Over-morticing is to be avoided; mortices shall be as tight as possible to the latch. If gaps around the case exceed 2mm, then these must be made good with intumescent mastic or sheet material. Holes for spindles or cylinders should be kept as small as is compatible with the operation of the hardware.

Where glazing apertures are also incorporated, and are positioned such that locks/latches are included in the margin between the aperture and door edge, care must be taken to ensure that the effective door 'stile' is not weakened by the mortice. It is a condition of this assessment that, except where tubular latches are employed, the margin must be at least 75mm wider than the lock/latch mortice. If the mortice latch/lock is fitted in line with a 'rail' between two apertures, no part of the lock mortice shall be closer than 50mm to the edge of any aperture.

H.3 Door Closers

Each hinged door leaf must be fitted with a self-closing device unless they are normally kept locked shut and labelled as such with an appropriate sign which complies with the BS 5499 series of standards.

Overhead surface mounted closers are recommended. Concealed overhead and concealed jamb mounted closers are not approved by this Report.

Surface mounted overhead door closers (and accessories such as soffit brackets) may be used if they have been tested, assessed or otherwise approved for use on unlatched FD60 cellulosic door leaves in timber frames. Any accessory that is located within the door reveal must have appropriate test or assessment evidence. In addition, where areas of uninsulated glazing are adjacent to the closer, the selected closer type must have been tested on the unexposed face of an uninsulated steel door, or a fully glazed door fitted with uninsulating glass, to demonstrate that the closer does not emit flammable fluids onto the glass face that would otherwise cause integrity failure before the required period of fire resistance.

It is essential that all closers are of the correct power rating for the width and weight of the doorsets (minimum power size 3). They must be fitted according to the manufacturer's instructions, and be adjusted so that they are capable of fully closing the door leaf, against any friction imposed by the latch (and smoke seals, if fitted), from any position of opening.

H.4 Non-Essential Hardware Items

H.4.1 Push plates, kick plates, etc

Plastic, pvc or metal plates may be surface-mounted to the doors, but, if more than 800mm in length by nominally 200mm wide, they must be attached in a way that would prevent them distorting the door leaf, e.g. glued with thermally softening adhesive or screwed with short aluminium screws and fitted in such a way so they will not be prevented from falling away by being trapped under door stops, glazing beads or handle escutcheons etc.

H.4.2 Pull handles

These may be fixed to the doorsets, provided that the fixing points are no greater than 800mm apart. Pull handles that are fixed through the leaf should use clearance holes as close fitting as possible to the bolt.

APPENDIX I

Summary of Fire Test Evidence

Test Report	Configuration Tested	Leaf Size Tested	Test Standard	Integrity (Minutes)
QH150 Rev 1	LSASD	2132 high x 1084 wide	BS476: Part 22: 1987	96
QC097-2	LSASD	2020 high x 950 wide	BS476: Part 22: 1987	109
RA148-2 Rev 1	LSASD	2108 high x 908 wide	BS476: Part 22: 1987	98
RA148-1 Rev 1	LSASD	2097 high x 899 wide	BS476: Part 22: 1987	100
PF059-1	LSASD	2100 high x 874 wide	BS476: Part 22: 1987	107

LSASD = Latched, Single Acting, Single leaf Door assembly

Note: Where appropriate, fire test evidence from glass, hardware, and intumescent seal manufacturers has also been considered when preparing this Field of Application Report.