

Title:

Extended Application Report
for Falcon Panel Products,
Stredor 44 EI30 FED,
30 Minute (integrity and
insulation) Fire Resisting
Doorsets to
BS EN 15269-3: 2012

WF Report:

WF 428388

WF File Reference:

WF 428388

Issue Date: 29th June 2020

Prepared for:

Falcon Panel Products Ltd
Clock House
Station Approach
Shepperton
TW17 8AN

Contents

	Page No.
1 Foreword	3
2 Details of the Product.....	4
3 Test Evidence.....	7
4 Test Samples.....	21
5 General Description of Construction	23
6 Configurations and Orientation	25
7 Leaf Sizes.....	26
8 Door Frames.....	28
9 Door Leaf Glazing.....	30
10 Environmental Seals.....	34
11 Intumescent Materials.....	35
13 Tested Hardware	38
14 Leaf/Frame Gaps.....	44
15 Supporting Construction and Attachment (Technique) of Door Frame	44
16 Application Range – Product Family	46
17 Fire Performance Parameters.....	46
18 Declaration by the Applicant	47
19 Limitations	48
20 Validity.....	49

Appendices

Appendix A – Revisions and Amendments	50
---	----

Falcon Panel Products Ltd supports third-party certification for the processing, manufacture, installation and maintenance of fire door assemblies. This document remains the property of Falcon Panel Products Ltd. It is the responsibility of the reader to ensure that any product manufactured using the evidence within is fit for purpose. This document details a subset of evidence from an extensive testing regime covering a wide range of products. Further documentation can be found on our website at <https://www.falconpp.co.uk/doorinfo>

1 Foreword

This Extended Field of Application (EXAP) report has been commissioned by Falcon Panel Products Ltd and relates to the fire resistance of the Stredor 44 EI30 FED product family, which comprises a 30 minute fire resisting timber based doorset design.

This EXAP report concerns test results obtained in accordance with test method BS EN 1634-1: 2014 + A1 2018; *Fire resistance and smoke control tests for door and shutter assemblies, openable windows and elements of building hardware - Part 1: Fire resistance test for door and shutter assemblies and openable windows.*

The extended application process is carried out in conformity with the following standards, as appropriate:

- BS EN 15269-1: 2019; *Extended application of test results for fire resistance and/or smoke control for door, shutter and openable window assemblies, including their elements of building hardware – Part 1: General Requirements*
- BS EN 15269-3: 2012; *Extended application of test results for fire resistance and/or smoke control for door, shutter and openable window assemblies, including their elements of building hardware – Part 3: Fire resistance of hinged and pivoted timber doorsets and openable timber framed windows*
- BS EN 15269-20: 2009; *Extended application of test results for fire resistance and/or smoke control for door, shutter and openable window assemblies, including their elements of building hardware – Part 20: Smoke control for hinged and pivoted steel, timber and metal framed glazed doorsets*

The report is to be used for extending the field of application for the Stredor 44 EI30 FED product family and has been written in accordance with the principles outlined in BS EN 15725: 2010; *Extended application reports on the fire performance of construction products and building elements.*

The report is to be used to support the formal fire resistance classification for the Stredor 44 EI30 FED product family against BS EN 13501-2: 2016; *Fire classification of construction products and building elements Part 2: Classification using data from fire resistance tests, excluding ventilation services.*

The scope presented in this report relates to the behaviour of the proposed door design variations with associated hardware under the particular conditions of the test; they are not intended to be the sole criterion for considering the potential fire hazard of the door assembly in use.

To prepare this EXAP, in accordance with Annex A of BS EN 15269-3: 2012, the EXAP rules given in table A.1 and table A.2 of BS EN 15269-3: 2012 have been applied by experts competent in the field of fire resistance testing of hinged or pivoted doorsets with timber based leaves.

2 Details of the Product

2.1 Product Technical Specification

The technical specification for the Stredor 44 EI30 FED doorset construction being considered within this EXAP report is summarised as follows:

- The door blank design for the Stredor 44 EI30 FED product family comprises two variations; Type A and Type B. The door blank types are summarised below:

Type A:

- (Inner Core Layer) – 4mm poplar ply (510kg/m³)
- (Outer Core Layers) – 15mm pine lamels (480kg/m³)
- (Surface Core Layer) – 4.6mm poplar ply (510kg/m³)
- Facing: 0.4mm EV (600kg/m³)

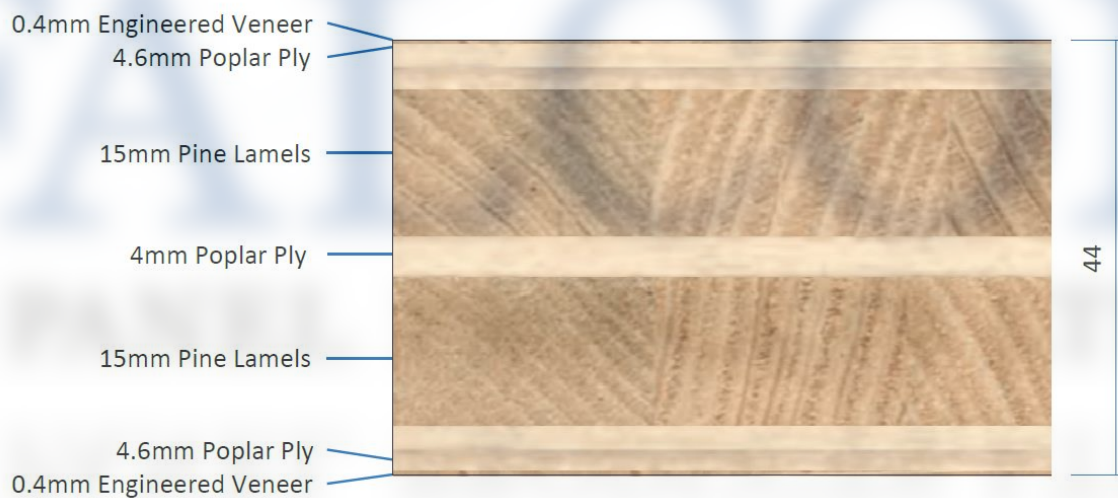

Fig. 1 – Cross section through Type A door blank design

Type B:

- (Inner Core Layer) – 2.1mm poplar ply (510kg/m³)
- (Outer Core Layers) – 19.5mm pine lamels (480kg/m³)
- (Surface Core Layer) – 1.4mm poplar ply (510kg/m³)
- Facing: 0.4mm beech veneer (600kg/m³)



Fig.2 – Cross section through Type B door blank design

- The door leaf thickness is nominally 44mm thick and is hung within a timber door frame.
- The doorset design incorporates hardware, intumescent seals and non-intumescent seals (i.e. smoke and weather seals).
- The door design has been tested against the relevant EN standard for fire resisting door assemblies, BS EN 1634-1.
- The scope of application for the Stredor 44 EI30 FED product family contained in this EXAP report is intended for 30 minute fire resisting applications with integrity and insulation performance and ambient temperature smoke control.

Notes:

1. The extended application for smoke control is dealt with in a separate EXAP document (referenced: WF 428364). In some instances it has been necessary to limit the extension to scope for fire resistance in this document for the purpose of classification to BS EN 13501-2: 2016. Any restrictions in the extension to scope for fire resistance have been identified in this report, as appropriate.
2. The extended application presented in this report is relevant to Stredor 44 EI30 FED doorsets constructed using both Type A and Type B Stredor door blanks. In order to provide a scope that can be applied to doorsets constructed using either of the door blank types without limitations, the results from the test evidence generated on the doorset containing the door blank that demonstrated the lower performance has been used to define the maximum field of application (e.g. over-run in performance and leaf distortion), according to the rules defined in BS EN 15269-3: 2012, as appropriate.

2.2 Product Family

The product family is referenced as Stredor 44 EI30 FED and the field of application defined in this report is based on the fire resistance test evidence for the doorset design, which is summarised in section 3. Analysis of specific construction details that require assessment using the rules given in BS EN 15269-3: 2012 are given within this report against the relevant element of construction, as appropriate.

The scope of application for the Stredor 44 EI30 FED product family is summarised below and is applicable to doorsets constructed using both the Type A and Type B door blanks:

- Latched, single acting, single leaf doorsets opening towards and away from fire test conditions
- Alternative doorset dimensions (smaller and larger than that tested)
- The doorset has various decorative and protective face options to suit end use application and aesthetic requirements
- Hardware options: steel butt hinges, multi-point locking system, handles, jamb mounted closer, overhead face fixed closer, door viewers, letter plates, door knockers

2.3 Intended Use

The intended use of the doorset is summarised below:

A pedestrian doorset including any frame, door leaf or leaves which is provided to give a fire resisting capability when used for the closing of permanent openings in fire resisting separating elements, which together with the building hardware and any seals (whether provided for the purpose of fire resistance or smoke control or for other purposes such as draught or acoustics) which form the assembly.

3 Test Evidence

The test evidence summarised below has been generated to support the fire resistance performance of the door design that is the subject of this EXAP report.

Note: dimensions are in mm unless otherwise stated.

Abbreviations: (h) = height; (w) = width; (t) = thickness; (d) = depth.

Latches fitted but disengaged for the test, are reported as 'unlatched'

3.1 Test WF 426419

The referenced test report, the essential details of which are summarised below, is the primary data for the Stredor 44 EI30 FED design for 30 minute integrity and insulation performance and supports the inclusion of: Sealed Tight Solutions Limited (STS) seals, STS hardware protection, STS glazing system, face-fixed mouldings, 15mm Pyrostop glass and aluminium threshold with Type A and Type B Stredor 44.

Date of Test:	27 th February 2020
Identification of Test Body:	Warringtonfire Testing and Certification Ltd. UKAS No. 1762
Sponsor:	Falcon Panel Products Ltd
Tested Product:	Two latched, single-acting, single-leaf doorsets - LSASD
Tested Orientation:	Doorset A: Stredor 44mm Type A door blank hung opening in towards heating condition Doorset B: Stredor 44mm Type B door blank hung opening in towards heating condition
Summary of Test Specimen:	<p><u>LEAF:</u> Overall Size (both leaves): 2399mm(h) x 1047(w) x 44mm(t)</p> <p>Doorset A Core:</p> <ul style="list-style-type: none"> • Falcon Panel Products Stredor 44mm Type A <ul style="list-style-type: none"> ○ (Inner Core Layer) – 4mm poplar ply (510kg/m³) ○ (Outer Core Layers) – 15mm pine lamels (480kg/m³) ○ (Surface Core Layer) – 4.6mm poplar ply (510kg/m³) ○ Facing: 0.4mm EV (600kg/m³) <p>Doorset B Core:</p> <ul style="list-style-type: none"> • Falcon Panel Products Stredor 44mm Type B <ul style="list-style-type: none"> ○ (Inner Core Layer) – 2.1mm poplar ply (510kg/m³) ○ (Outer Core Layers) – 19.5mm pine lamels (480kg/m³) ○ (Surface Core Layer) – 1.4mm poplar ply (510kg/m³) ○ Facing: 0.4mm beech veneer (600kg/m³)

Falcon Panel Products Ltd supports third party certification for the processing, manufacture, installation and maintenance of fire door assemblies. This document remains the property of Falcon Panel Products Ltd. It is the responsibility of the reader to ensure that any product manufactured using the evidence within this document is fit for purpose. This document details a subset of evidence from an extensive testing regime covering a wide range of products. Further documentation can be found on our website at <https://www.falconpp.co.uk/doorinfo>

Summary of Test Specimen continued:	<p>Decorative Moulding (both leaves): 70x19mm European redwood, affixed with 18g x 30mm pins</p> <p>Lipping (both leaves): Sapele (640kg/m³), 8mm thick to all four edges</p> <p><u>FRAME:</u></p> <p>Head & Jambs: European Redwood (510kg/m³), 69.5mm(d) x 44mm(w), with 42mm(w) x 15mm(d) integral stop.</p> <p>Frame Fixing: 4No. Ø5 x 80 steel woodscrews, 500-600mm centres</p> <p>Threshold: Sealed Tight Solutions Limited STH004 aluminium threshold. 1111mm(w) x 15mm(h) x 47mm(d)</p> <p><u>INTUMESCENT:</u></p> <p>Frame Reveal: 2no 10x4mm Sealed Tight Solutions Limited ST104FO 10mm apart, 7mm from the opening face.</p> <p><u>GLAZING:</u></p> <p>Glass: Pilkington Pyrostop 15mm thick</p> <p>Overall Size: 394x1534mm</p> <p>Aperture Size: 400x1540mm</p> <p>Sight Size: 358x1498mm</p> <p>Beading: Sapele (640kg/m³), 19mm(w) x 21mm(h) with 15° chamfer and a 6x6mm bolection</p> <p>Bead Fixing: 16g x 50mm long steel pins at 25-35°, 150mm centres & 50mm from corners.</p> <p><u>GLAZING SYSTEM:</u></p> <p>Glazing Perimeter: 9x3mm Sealed Tight Solutions Limited STS ST105-3 closed-cell foam tape</p> <p>Glazing Liner: 15x2mm Sealed Tight Solutions Limited STS302 (cut in half)</p> <p><u>SMOKE/ACOUSTIC SEALS:</u></p> <p>Head and Jambs: 1no 10x9mm Sealed Tight Solutions Limited ST1009 self-adhered to the corner of the stop and frame reveal.</p> <p>Leaf bottom edge: 12x20mm Sealed Tight Solutions Limited ST422 drop seal centrally rebated into the bottom edge of the leaf.</p>
--	---

Summary of Test Specimen continued:	<p><u>HARDWARE:</u> Hinges: 4no Eurospec HIN 1433/13 Closer: Astra 4003 Lock/Latch: ERA SureFire Heritage 2 hook multi-point door lock with 75mm ERA Fortress 3* thumbturn cylinder* Cylinder Pull: ERA Fab&Fix Heritage Euro Cylinder Pull* *NOTE: Cylinder and pull fitted in alternate orientations for Doorset A and B Lock/Latch Size:</p> <ul style="list-style-type: none">• Forend: 1634x20mm• Top/bottom keep: 151x24mm• Top/bottom case: 150x42mm• Centre keep: 170x24mm• Centre case: 213x61mm <p>Lock/Latch Status: Engaged for test (auto firing multi-point latches but with the central deadbolt withdrawn)</p> <p>Eye viewer: Sealed Tight Solutions Limited 4008 Barrel: Ø14mm, Footprint: Ø16mm fitted 849mm from the leaf head</p> <p><u>HARDWARE PROTECTION:</u> Under Hinge: 1mm Sealed Tight Solutions Limited raw graphite Lock/Latch:</p> <ul style="list-style-type: none">• Forend plate: None• Top/bottom keep: Sealed Tight Solutions Limited 1mm graphite based intumescent• Top/bottom case: Sealed Tight Solutions Limited 1mm graphite based intumescent• Centre keep: Sealed Tight Solutions Limited 1mm graphite based intumescent• Centre case: Sealed Tight Solutions Limited 1mm graphite based intumescent <p>Eye viewer: Sealed Tight Solutions Limited 1mm graphite based intumescent</p>
Test Standard:	BS EN 1634-1:2014 + A1: 2018

3.1.1 Test WF 426419

The following table summarises the results of the test and provides information on the performance of the doorsets in fire test conditions that is required to extend the scope of application for the design using the rules in BS EN 15269-3: 2012.

Doorset Reference	Result (minutes)				Category of performance ¹ (A or B)	Distortion ² (Low, Med, High)
	Integrity	Insulation		Radiation		
		(I ₁) ³	(I ₂) ⁴			
Doorset A	35	35	35	42	A	Low
Doorset B	41	31	38	42	B	Low

1. In accordance with clause 13.3.2 of BS EN 1634-1: 2014 + A1: 2018
2. In accordance with Annex A of BS EN 15269-3: 2012
3. Supplementary procedure for maximum temperature rise (I₁) in accordance with 11.2.5 in BS EN 1634-1: 2014 + A1: 2018
4. Normal procedure for maximum temperature rise (I₂) in accordance with 11.2.4 in BS EN 1634-1: 2014 + A1: 2018

Falcon Panel Products Ltd supports third-party certification for the processing, manufacture, installation and maintenance of fire door assemblies. This document remains the property of Falcon Panel Products Ltd. It is the responsibility of the reader to ensure that any product manufactured using the evidence within is fit for purpose. This document details a subset of evidence from an extensive testing regime covering a wide range of products. Further documentation can be found on our website at <https://www.falconpp.co.uk/doorinfo>

3.2 Test WF 416690 – Issue 2

The referenced test report, the essential details of which are summarised below, is the secondary data for supporting the inclusion of ERA SureFire Classic multipoint locking system, various items of hardware and STS hardware protection into the Stredor 44 EI30 FED design. The data also provides evidence for the restraining and supporting hardware exposed to test conditions in both directions:

Date of Test:	8 th August 2019
Identification of Test Body:	Warringtonfire Testing and Certification Ltd. UKAS No. 1762
Sponsor:	Falcon Panel Products Ltd
Tested Product:	Two latched, single-acting, single-leaf doorsets - LSASD
Tested Orientation:	Doorset A hung opening out away from heating condition Doorset B hung opening in towards heating condition
Summary of Test Specimen:	<p><u>LEAF:</u> Overall Size (both leaves): 2153mm(h) x 933(w) x 44mm(t) Core:</p> <ul style="list-style-type: none"> • Falcon Panel Products Stredor 44mm Type A <ul style="list-style-type: none"> ○ (Inner Core Layer) – 4mm poplar ply (510kg/m³) ○ (Outer Core Layers) – 15mm pine lamels (480kg/m³) ○ (Surface Core Layer) – 4.6mm poplar ply (510kg/m³) ○ Facing: 0.4mm EV (600kg/m³) <p>Lipping: Sapele (640kg/m³), 8mm thick to all four edges</p> <p><u>FRAME:</u> Head & Jambs: Sapele (621kg/m³), 80mm(d) x 44mm(w), with 33mm(w) x 12mm(d) integral stop. Frame Fixing: 4No. Ø10 x 100 steel woodscrews, 400-500mm centres Threshold: Non-combustible</p> <p><u>INTUMESCENT:</u> Frame Reveal: 2no 10x4mm Pyroplex 8500 separated by 5mm either side of the centre line of the frame reveal</p>

Falcon Panel Products Ltd supports third-party certification for the processing, manufacture, installation and maintenance of Falcon Panel Products Ltd. This document remains the property of Falcon Panel Products Ltd. It is the responsibility of the reader to ensure that any product manufactured using the evidence within is fit for purpose. This document details a subset of evidence from an extensive testing regime covering a wide range of products. Further documentation can be found on our website at <https://www.falconpp.co.uk/doorinfo>

Summary of Test Specimen continued:

GLAZING:

Glass: Fireglass Pyrobelite 9EG, 11mm thick

Overall Size:

- Top: 984x224mm
- Bottom: 632x224mm

Aperture Size:

- Top: 990x230mm
- Bottom: 638x230mm

Sight Size:

- Top: 960x205mm
- Bottom: 610x205mm

Beading: Sapele (685kg/m³), 19mm(w) x 21mm(h) with 15° chamfer and a 13mm(w) x 6mm(h) rebate forming a 6x6mm bolection return

Bead Fixing: 1.6g x 50mm long steel pins at 25-35°, 150mm centres & 45mm from corners.

GLAZING SYSTEM:

Glazing Perimeter: 10x4mm Sealmaster Black Glazing Tape (BGT)

SMOKE/ACOUSTIC SEALS:

Head and Jambs: 1no 11x10mm Norseal NOR710 self-adhered to the corner of the stop and frame reveal.

Leaf bottom edge: 12x20mm Norseal NOR810S drop seal centrally rebated into the bottom edge of the leaf.

HARDWARE:

Hinges: 4no. Zoo ZHSS243RS butt hinge

Closer: Hoppe AR1500

Lock/Latch: ERA SureFire Classic 2 hook multi-point door lock with 70mm ERA Fortress 3* thumbturn cylinder

Lock/Latch Size:

- Forend: 1634x20mm
- Top/bottom keep: 136x24mm
- Top/bottom case: 150x41mm
- Centre keep: 170x24mm
- Centre case: 214x60mm

Lock/Latch Status: Engaged for test (auto firing multi-point latches but with the central deadbolt withdrawn)

Handle: ERA 1X000 lever type handle.

Eye viewer: ERA Fab&Fix Barrel: Ø12mm, Footprint: Ø16mm fitted 1500mm from the bottom of the leaf

Summary of Test Specimen continued:	<p>Letterplate: ERA Fab&Fix Numail door letterplate with security cowl fitted 850mm from the bottom of the leaf.</p> <p>Security Chain: ERA PVCu/Timber Door Chain 791-65 fitted 400mm down from the top of the leaf</p> <p>Numerals: ERA Fab&Fix Door Numerals FFNUM8BC</p> <p>Knocker: ERA Ingot Door Knocker – 4A550</p> <p><u>HARDWARE PROTECTION:</u></p> <p>Under Hinge: 1mm thick MAP</p> <p>Lock/Latch:</p> <ul style="list-style-type: none">• Forend plate: Sealed Tight Solutions Limited 1mm graphite based intumescent• Top/bottom keep: Sealed Tight Solutions Limited 1mm graphite based intumescent• Top/bottom case: Sealed Tight Solutions Limited 1mm graphite based intumescent• Centre keep: Sealed Tight Solutions Limited 1mm graphite based intumescent• Centre case: Sealed Tight Solutions Limited 1mm graphite based intumescent <p>Eye viewer: 0.5mm graphite wrap supplied with viewer</p> <p>Letterplate: 40x2mm Sealed tight solutions Limited graphite based intumescent, wrapped twice around letterplate channel</p>
Test Standard:	BS EN 1634-1:2014+A1:2018

Falcon Panel Products Ltd supports third-party certification for the processing, manufacture, installation and maintenance of fire door assemblies. This document remains the property of Falcon Panel Products Ltd. It is the responsibility of the reader to ensure that any product manufactured using the evidence within is fit for purpose. This document details a subset of evidence from an extensive testing regime covering a wide range of products. Further documentation can be found on our website at <https://www.falconpp.co.uk/doorinfo>

3.2.1 Test WF 416690 - Issue 2 Summary of Results

The following table summarises the results of the test and provides information on the performance of the doorsets in fire test conditions that is required to extend the scope of application for the design using the rules in BS EN 15269-3: 2012.

Doorset Reference	Result (minutes)			Radiation	Category of performance ¹ (A or B)	Distortion ² (Low, Med, High)
	Integrity	Insulation				
		(I ₁) ³	(I ₂) ⁴			
Doorset A	34	N/A	33	50	A	Low
Doorset B	50	N/A	29	50	B	Low

1. In accordance with clause 13.3.2 of BS EN 1634-1: 2014 + A1: 2018
2. In accordance with Annex A of BS EN 15269-3: 2012
3. Supplementary procedure for maximum temperature rise (I₁) in accordance with 11.2.5 in BS EN 1634-1: 2014 + A1: 2018
4. Normal procedure for maximum temperature rise (I₂) in accordance with 11.2.4 in BS EN 1634-1: 2014 + A1: 2018

NB: The insulation performance recorded above is related to the glazed areas and is not being considered as part of this EXAP. The cited test evidence can therefore be used to support the alternative hardware.

3.3 Test EFR-18-H-003671

The referenced test report, the essential details of which are summarised below, is the primary data for supporting the inclusion of ERA SureFire Classic multipoint locking mechanism, STS seals and STS hardware protection into the Stredor 44 EI30 FED design. The data also provides evidence for the restraining and supporting hardware exposed to test conditions in both directions:

Date of Test:	15 th November 2018
Identification of Test Body:	Efectis France - COFRAC No. 1-1762
Sponsor:	Falcon Panel Products Ltd
Tested Product:	Two latched, single-acting, single-leaf doorsets - LSASD
Tested Orientation:	Doorset A: opening in towards heating condition Doorset B: opening out away from heating condition
Summary of Test Specimen:	<p><u>LEAF:</u> Overall Size (both leaves): 2402mm(h) x 1047(w) x 44mm(t) Core (Both Doorsets):</p> <ul style="list-style-type: none"> • Falcon Panel Products Stredor 44mm Type B <ul style="list-style-type: none"> ○ (Inner Core Layer) – 2.1mm poplar ply (510kg/m³) ○ (Outer Core Layers) – 19.5mm pine lamels (480kg/m³) ○ (Surface Core Layer) – 1.4mm poplar ply (510kg/m³) ○ Facing: 0.4mm beech veneer (600kg/m³) <p>Lipping (both leaves): Sapele (640kg/m³), 8mm thick to all four edges</p> <p><u>FRAME:</u> Head & Jambs: European Redwood (510kg/m³), 90mm(d) x 44mm(w), with 43mm(w) x 15mm(d) integral stop. Frame Fixing: 4No. Ø5 x 80 steel woodscrews, 500-600mm centres Threshold: Non-Combustible</p> <p><u>INTUMESCENT:</u> Frame Reveal: 2no 10x4mm Sealed Tight Solutions Limited ST104FO 10mm apart, 7mm from the opening face.</p>

Falcon Panel Products Ltd supports third party certification for the processing, manufacture, installation and maintenance of fire door assemblies. This document remains the property of Falcon Panel Products Ltd. It is the responsibility of the reader to ensure that any product manufactured using the evidence within is for the purpose. This document details a subset of evidence from an extensive testing regime covering a wide range of products. Further documentation can be found on our website at <https://www.falconpp.co.uk/doorinfo>

Summary of Test Specimen continued:

GLAZING:

Glass: Pyrobelite 9EG 12mm thick

Overall Size: 394x1534mm

Aperture Size: 400x1540mm

Sight Size: 370x1410mm

Beading: Sapele (640kg/m³), 19.5mm(w) x 23mm(h) with a 15° chamfer and a 8x6mm bolection

Bead Fixing: Ø3.5 x 50mm long steel pins at 25-35°, 150mm centres & 50mm from corners.

GLAZING SYSTEM:

Glazing Perimeter: 10x3mm Sealed Tight Solutions Limited STS ST105-3 GT closed-cell foam tape

SMOKE/ACOUSTIC SEALS:

Head and Jambs: 1no 10x9mm Sealed Tight Solutions Limited ST1009 self-adhered to the corner of the stop and frame reveal.

Leaf bottom edge: 12x20mm Sealed Tight Solutions Limited ST422 drop seal centrally rebated into the bottom edge of the leaf.

HARDWARE:

Hinges: 3no Royde & Tucker H207

Closer: Astra 4000 jamb-mounted concealed closer

Lock/Latch: ERA SureFire Classic 2 hook multi-point door lock with 75mm ERA Fortress 3* thumbturn cylinder*

Lock/Latch Size:

- Forend: 1634x20mm
- Top/bottom keep: 151x24mm
- Top/bottom case: 150x42mm
- Centre keep: 170x24mm
- Centre case: 213x61mm

Lock/Latch Status: Engaged for test (auto firing multi-point latches but with the central deadbolt withdrawn)

Handle: Stanza ZPZ090SC

Eye viewer: Sealed Tight Solutions Limited 4008 Barrel: Ø14mm, Footprint: Ø16mm fitted 1540mm from the bottom of the leaf

Summary of Test Specimen continued:	<p><u>HARDWARE PROTECTION:</u></p> <p>Under Hinge: 1mm Sealed Tight Solutions Limited raw graphite</p> <p>Lock/Latch:</p> <ul style="list-style-type: none"> • Forend plate: Sealed Tight Solutions Limited 1mm graphite based intumescent, interrupted where necessary to allow for free movement of mechanical parts. • Top/bottom keep: Sealed Tight Solutions Limited 1mm graphite based intumescent • Top/bottom case: Sealed Tight Solutions Limited 1mm graphite based intumescent • Centre keep: Sealed Tight Solutions Limited 1mm graphite based intumescent • Centre case: Sealed Tight Solutions Limited 1mm graphite based intumescent <p>Eye viewer: Sealed Tight Solutions Limited 1mm graphite based intumescent</p> <p>Closer forend and body: Sealed Tight Solutions Limited 1mm graphite based intumescent</p>
Test Standard:	EN 1634-1:2014 + A1: 2018

3.3.1 Test EFR-18-H-003671 Summary of Results

The following table summarises the results of the test and provides information on the performance of the doorsets in fire test conditions that is required to extend the scope of application for the design using the rules in BS EN 15269-3: 2012.

Doorset Reference	Result (minutes)			Radiation	Category of performance ¹ (A or B)	Distortion ² (Low, Med, High)
	Integrity	Insulation				
		(I ₁) ³	(I ₂) ⁴			
Doorset A	36	21	21	N/A	B	Low
Doorset B	36	32	32	N/A	B	Low

1. In accordance with clause 13.3.2 of BS EN 1634-1: 2014 + A1: 2018
2. In accordance with Annex A of BS EN 15269-3: 2012
3. Supplementary procedure for maximum temperature rise (I₁) in accordance with 11.2.5 in BS EN 1634-1: 2014 + A1: 2018
4. Normal procedure for maximum temperature rise (I₂) in accordance with 11.2.4 in BS EN 1634-1: 2014 + A1: 2018

NB: The insulation performance recorded above is related to the glazed areas and is not being considered as part of this EXAP. The cited test evidence can therefore be used to support the alternative hardware.

Falcon Panel Products Ltd supports third party certification for the processing, manufacture, installation and maintenance of Falcon Panel Products Ltd. This document remains the property of Falcon Panel Products Ltd. It is the responsibility of the reader to ensure that any product manufactured using this evidence with a view to its use in an extensive testing regime details a substantial amount of evidence from an extensive further documentation can be found on our website at <https://www.falconpp.co.uk/doorinfo>

3.4 Test WF 421795

The referenced test report, the essential details of which are summarised below, is secondary data for supporting the inclusion of: door closer and eye viewer into the Stredor 44 EI30 FED design, based on using a door core that is considered fundamentally the same for the purpose of adding the alternative hardware (Clause A.2 in Annex A of BS EN 15269-1: 2019 + AC: 2020 gives further explanation on the phrase 'fundamentally the same' or 'similar' and its use within the EN 15269 series of EXAP standards):

Date of Test:	21 st November 2019
Identification of Test Body:	Warringtonfire Testing and Certification Ltd. UKAS No. 1762
Sponsor:	Falcon Panel Products Ltd
Tested Product:	Two latched, single-leaf, single acting doorsets - LSASD
Tested Orientation:	Doorset A hung opening in towards heating condition Doorset B hung opening out away from heating condition
Summary of Test Specimen:	<p><u>LEAF:</u> Overall Size: 2100mm(h) x 950(w) x 44mm(t) Core: Falcon Panel Products Strebord 44mm particleboard (590kg/m³) Lipping: Sapele (640kg/m³), 8mm thick to all four edges</p> <p><u>FRAME:</u> Head & Jamb: Poplar (510kg/m³), 100mm(d) x 47mm(w), with 53mm(w) x 15mm(d) integral stop. Frame Fixing: 4No. Ø5 x 100 steel woodscrews, 600mm centres Threshold: Non-combustible</p> <p><u>INTUMESCENT:</u> Frame Reveal/Leaf Edges: 2no 10x4mm Sealed Tight Solutions Limited STS 104FO fitted 10mm apart and 7mm from the exposed face.</p> <p><u>SMOKE/ACOUSTIC SEALS:</u> Head and Jamb: 1no 11x5mm Sealed Tight Solutions Limited ST1009 acoustic/smoke seal self-adhered to the upstand of the stop. Leaf bottom edge: 12x20mm Sealed Tight Solutions Limited ST422 drop seal fitted centrally rebated into the bottom edge of the leaf.</p>

Falcon Panel Products Ltd supports the property of the door for the processing, manufacture, installation and maintenance of the door assemblies.
 This document remains the property of Falcon Panel Products Ltd.
 It is the responsibility of the reader to ensure that any product manufactured using the evidence within this report is for purpose.
 This document details a subset of evidence from an extensive testing regime covering a wide range of products.
 Further documentation can be found on our website at <https://www.falconpp.co.uk/doorinfo>

Summary of Test Specimen continued:	<p><u>HARDWARE:</u></p> <p>Hinges: 3no. Consort bearing butt hinge Ref CF5511 Closer: Dormakaba TS93 overhead closer Lock/Latch: Winkhaus AV3 3-point lock/latch fitted with a 70mm ERA fortress 3* thumbturn cylinder Lock/Latch Size:</p> <ul style="list-style-type: none">• Forend: 1770x20mm• Top/bottom keep: 160x22mm• Top/bottom case: 113x44mm• Centre keep: 245x22mm• Centre case: 185x63mm <p>Lock/Latch Status: Engaged for test Handle: Consort CH100/G4 lever type handle and Consort CH311/8/316 escutcheon. Eye viewer: DESWLAF EI30 Barrel: Ø14mm, Footprint: Ø27mm fitted 1500mm from the bottom of the leaf Letterplate: Royde & Tucker LP08 letterplate with TS008 cowl fitted 900mm from the bottom of the leaf.</p> <p><u>HARDWARE PROTECTION:</u></p> <p>Under Hinge: Sealed Tight Solutions Limited 1mm thick graphite based intumescent Encasing latch bodies: 1mm interdens supplied as kit with lock Under keeps: 1mm interdens supplied as kit with lock Eye viewer: Sealed Tight Solutions Limited 1mm thick raw graphite</p>
Test Standard:	BS EN 1634-1:2014+A1:2018

3.4.1 Test WF 421795 Summary of Results

The following table summarises the results of the test and provides information on the performance of the doorsets in fire test conditions that is required to extend the scope of application for the design using the rules in BS EN 15269-3: 2012.

Doorset Reference	Result (minutes)			Radiation	Category of performance ¹ (A or B)	Distortion ² (Low, Med, High)
	Integrity	Insulation				
		(I ₁) ³	(I ₂) ⁴			
Doorset A	35	28	35	38	B	Low
Doorset B	38	38	38	38	B	Low

1. In accordance with clause 13.3.2 of BS EN 1634-1: 2014 + A1: 2018
2. In accordance with Annex A of BS EN 15269-3: 2012
3. Supplementary procedure for maximum temperature rise (I₁) in accordance with 11.2.5 in BS EN 1634-1: 2014 + A1: 2018
4. Normal procedure for maximum temperature rise (I₂) in accordance with 11.2.4 in BS EN 1634-1: 2014 + A1: 2018

Falcon Panel Products Ltd supports third-party certification for the processing, manufacture, installation and maintenance of fire door assemblies. This document remains the property of Falcon Panel Products Ltd. It is the responsibility of the reader to ensure that any product manufactured using the evidence within is fit for purpose. This document details a subset of evidence from an extensive testing regime covering a wide range of products. Further documentation can be found on our website at <https://www.falconpp.co.uk/doorinfo>

4 Test Samples

The following table provides a summary of the test specimens:

Test Report Ref.	Sampling Procedure	Conditioning and Ageing	Pre-Fire Tests
WF 426419	Both doorsets were sampled by Warringtonfire Testing and Certification Ltd (Notified Body: 1121) on the 11 th & 12 th February 2020. Sample report no: FM424838	Prior to test, the doorset was stored in climatic conditions approximate to those in normal service. The ambient air temperature was 8°C at the start of the test with a maximum variation of ±1°C during the test	Prior to testing, the doorsets were subjected to appropriate mechanical pre-test conditioning in accordance with the requirement of BS EN 16034. Closer forces measured in accordance with BS EN 1634-1: 2014 Section 10.1.3 See individual test reports for details
WF 416690	The doorset and components (apart from the 3 point latch on doorset B) were sampled by Warringtonfire Testing and Certification Ltd (Notified Body: 1121) on the 31 st July 2019. Sample report no. FM416656	Prior to test, the doorset was stored in climatic conditions approximate to those in normal service. The ambient air temperature was 23°C at the start of the test with a maximum variation of ±0°C during the test	Prior to testing, the doorsets were subjected to appropriate mechanical pre-test conditioning in accordance with the requirement of BS EN 16304. Closer forces measured in accordance with BS EN 1634-1: 2014 Section 10.1.3 See individual test reports for details
EFR-18-H-003671	The doorset and components were sampled by EXOVA (Notified Body: 1124) on the 1 st November 2018. Sample report no: PS 18 1001	The ambient air temperature was 17°C at the start of the test	In accordance with EN 14600: 2015, suitability, 'proper operation' and self-closing tests were carried out before the fire test. Closer forces measured in accordance with BS EN 1634-1: 2014 Section 10.1.3 See individual test reports for details

Test Report Ref.	Sampling Procedure	Conditioning and Ageing	Pre-Fire Tests
WF 421795	No information on sampling is available. The component parts of the doorsets were identified based on information provided by the client and verified and agreed by the laboratory insofar as reasonably practicable ¹	Prior to test, the doorset was stored in climatic conditions approximate to those in normal service. The ambient air temperature was 8°C at the start of the test	Prior to testing, the doorsets were subjected to appropriate mechanical pre-test conditioning in accordance with the requirement of BS EN 16304. Closer forces measured in accordance with BS EN 1634-1: 2014 Section 10.1.3 See individual test reports for details

Notes:

1. The approved guidance on the use of historic data, issued by the Fire and Doors and Windows Sector Groups (SH02 and SG06 respectively) of the GNB CPR, document referenced NB-CPR/SH02/SG06-18/001r1, has been used to permit the use of this test report for the purpose of including the specific alternative items of hardware into the Stredor 44 EI30 FED design considered in this EXAP report.

Falcon Panel Products Ltd supports third-party certification for the processing, manufacture, installation and maintenance of fire door assemblies. This document remains the property of Falcon Panel Products Ltd. It is the responsibility of the reader to ensure that any product manufactured using the evidence within is fit for purpose. This document details a subset of evidence from an extensive testing regime covering a wide range of products. Further documentation can be found on our website at <https://www.falconpp.co.uk/doorinfo>

5 General Description of Construction

5.1 Door Leaf Construction

5.1.1 Stredor 44 Type A

The construction of door leaves to this design constructed using Stredor 44 Type A must be to the following specification:

Element		Material	Dimensions (mm)	Density (kg/m ³)
Core 3 layers (42 thick overall)	Inner core	Poplar ply located central within the core make-up	4 (t)	510 ¹
	Outer core	Vertically oriented finger jointed pine lamels	15 (t) overall	480 ¹
	Surface core	Poplar ply each side of outer core	4.6 (t)	510 ¹
Outer facings		EV veneer	0.4 (t)	600 ¹
Adhesive	Lippings	Technomelt PUR 270/7G (applied by hot melt edge bander)	-	-
		Norbord Caberfix D4 PU (hand applied and clamped in position)	-	-
	Facings and core	Melamine and urea formaldehyde ²	-	-
Lippings – all edges		Hardwood	See section 5.1.3	See section 5.1.3

Notes:

1. Stated by manufacturer
2. Adhesive for facings and core applied at the factory for the Type A core product. Type, amount and application of adhesive assumed to remain consistent for the purpose of this EXAP.

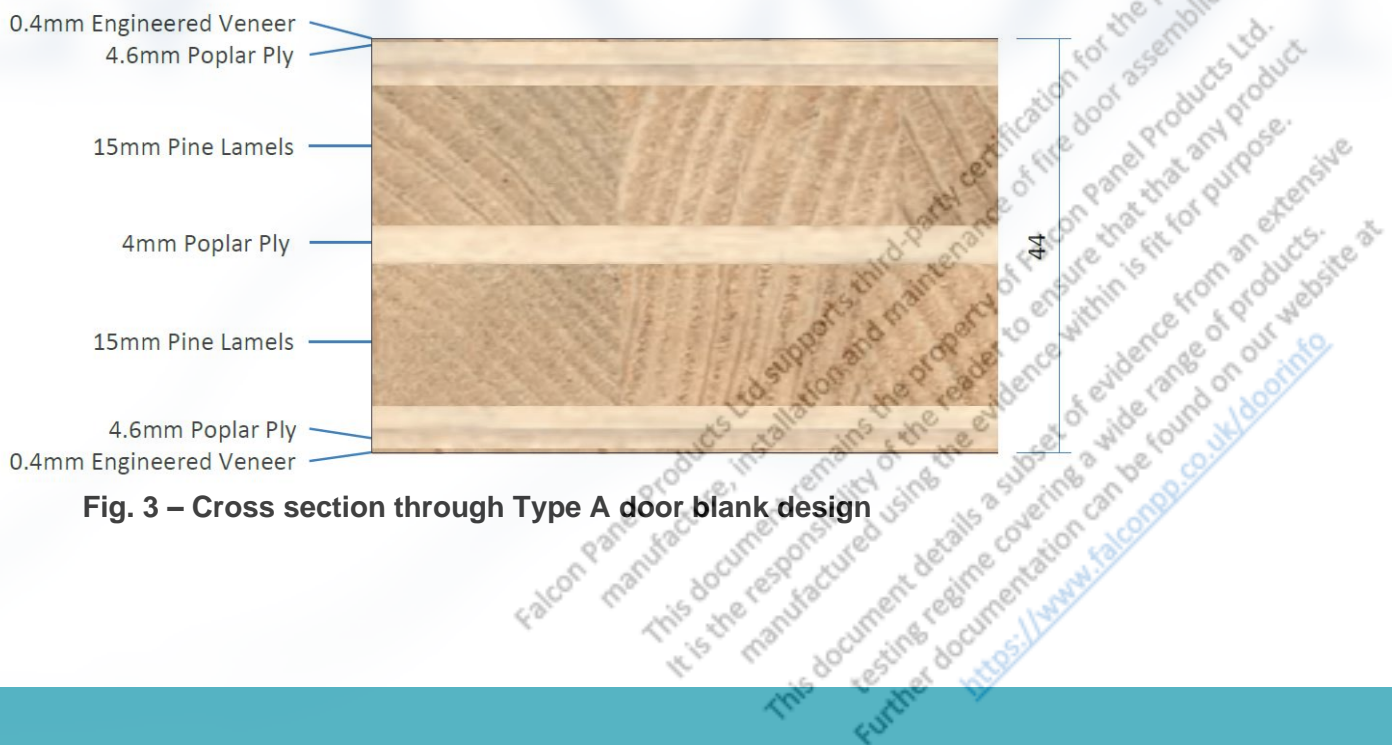

5.1.2 Stredor 44 Type B

The construction of door leaves to this design constructed using Stredor 44 Type B must be to the following specification:

Element		Material	Dimensions (mm)	Density (kg/m ³)
Core 3 layers (42 thick overall)	Inner core	Poplar ply located central within the core make-up	2.1 (t)	510 ¹
	Outer core	Vertically oriented finger jointed pine lamels	19.5 (t) overall	480 ¹
	Surface core	Poplar ply each side of outer core	1.4 (t)	510 ¹
Outer facings		Beech veneer	0.4 (t)	600 ¹
Adhesive	Lippings	Technomelt PUR 270/7G (applied by hot melt edge bander)	-	-
		Norbord Caberfix D4 PU (hand applied and clamped in position)	-	-
	Facings and core	PVA and Melamine and urea formaldehyde ²	-	-
Lippings – all edges		Hardwood	See section 5.1.3	See section 5.1.3

Notes:

1. Stated by manufacturer
2. Adhesive for facings and core applied at the factory for the Type B core product. Type, amount and application of adhesive assumed to remain consistent for the purpose of this EXAP.

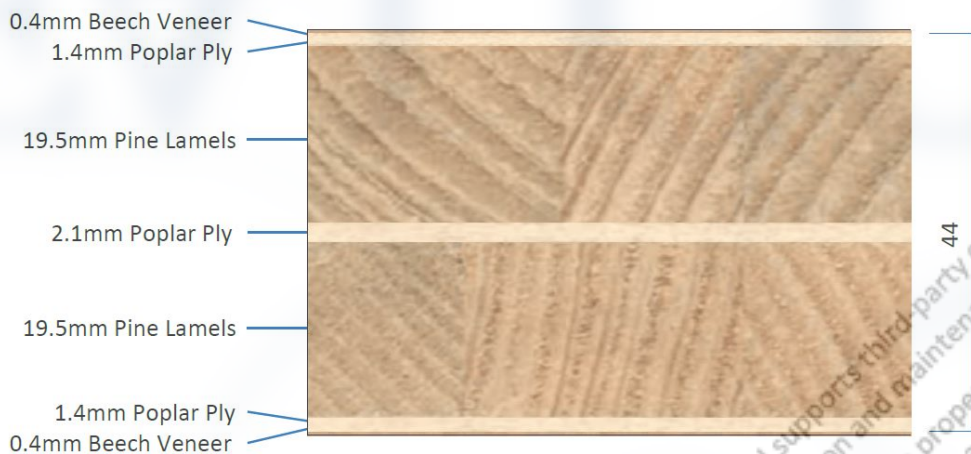

Fig. 4 – Cross section through Type B door blank design

5.1.3 Door Leaf Design Options

The following design options are permitted. All other leaf construction details must remain as tested and summarised above:

1. The door leaf can be reduced in height and width from any edge without restriction prior to fitting the hardwood lipping, as required (in line with EXAP rule A.3.1 – refers to DIAP rules in BS EN 1634-1)
2. The door leaf must be lipped on all edges according to EXAP rule A.5.17.
3. Based on the submitted test evidence it is permitted to use the following adhesives and gluing applications for the lippings for Type A and Type B door cores. Both types of adhesive and application methods have been tested with Stredor 44 Type A and Type B door cores ::
 - a. Technomelt PUR 270/7G (applied by hot melt edge bander)
 - b. Norbord Caberfix D4 PU (hand applied and clamped in position)
4. EXAP rule A.5.15 states that lippings tested between 3mm and 12mm can be increased by 25% in thickness up to a maximum of 12mm thick and can be reduced by a maximum of 25% providing the lipping is not reduced below 3mm thick. The tested lipping thickness at 8mm thick permits a lipping thickness between a minimum of 6mm and a maximum of 10mm thick
5. The lipping can be constructed using alternative hardwood timber meeting or exceeding 640kg/m³ (excluding beech – fagus sylvatica) in accordance with EXAP rule A.5.14
6. The door leaf can have applied face fixed decorative mouldings applied - see section 12.3

6 Configurations and Orientation

6.1 Door Leaf Configurations

The doorset designs referenced in section 3 were all tested fitted with the latches engaged. The following doorset configuration is therefore permitted for the design covered by this EXAP report:

Abbreviation	Description
LSASD	Latched, single acting, single leaf doorsets ¹

Notes:

1. All tests were conducted using doorsets fitted with auto firing multi-point latches but with the central deadbolt withdrawn. The doorset must therefore be configured with all three latching points of the multi-point lock engaged when the door is in the closed position but it is not necessary to engage the central deadbolt to maintain the fire resistance or smoke control performance of the doorset.

6.2 Door Leaf Orientation

The primary fire resistance test for this design included doorsets where the door leaves opened both towards and away from the fire. Based on this testing, the extended scope presented in this EXAP report is applicable to doorsets with leaves that are hung to open either away from or towards the fire risk side of the doorset, making the Stredor 44 EI30 FED product family bi-directional with respect to the fire risk.

The orientation of the door leaves also takes into consideration the testing of the restraining hardware in both directions with respect to exposure to fire test conditions as outlined in DIAP rule 13.4 in BS EN 1634-1: 2014 + A1:2018.

7 Leaf Sizes

7.1 Maximum leaf sizes

7.1.1 Doorsets fitted with Surefire Heritage Locksets

The doorset design has only been tested with the Heritage lockset opening towards the furnace. In order to permit the doorsets with Heritage locksets, in both directions with respect to exposure to fire test conditions, the Surefire Heritage lockset needs to be tested in both directions according to EN 1634-1.

The requirement for the Stredor 44 EI30 FED product family is for bi-directional doorsets with respect to fire risk and therefore Heritage locksets are not permitted for use with this doorset design.

7.1.1 Doorsets fitted with Surefire Classic Locksets

The leaf size increase rules given in EXAP rule A.3.2 have been used to calculate the maximum leaf size envelope for doorsets fitted with the Surefire Classic locksets. The Surefire Classic locksets have been included in a test to EN 1634-1 in both directions with respect to exposure to fire test conditions.

The performance of doorset A tested in WF 416690 has been used to calculate the leaf size envelope for the Stredor 44 EI30 FED doorset design fitted with Surefire Classic locksets.

The Stredor 44 EI30 FED product family can include door leaves of the following dimensions when fitted with the Surefire Classic locksets:

34mins (tested performance) – 30mins (required performance) = 4mins over run

$(4/30) \times 100 = 13\%$ over run in performance

13×0.5 (the amount the over-run, as a percentage, is to be factored by in order to calculate leaf size increase for a low distortion door at 30 minutes performance) = 6.5%

Leaf height and width can be increased by 6.5% according to the EXAP rule A.3.2 and based on the tested performance of the doorset.

Tested height: 2153mm

Increased (maximum) height: 2153×1.065 (i.e. 6.5% increase) = 2292mm

Tested width: 933mm

Increased (maximum) width: 933×1.065 (i.e. 6.5% increase) = 993mm

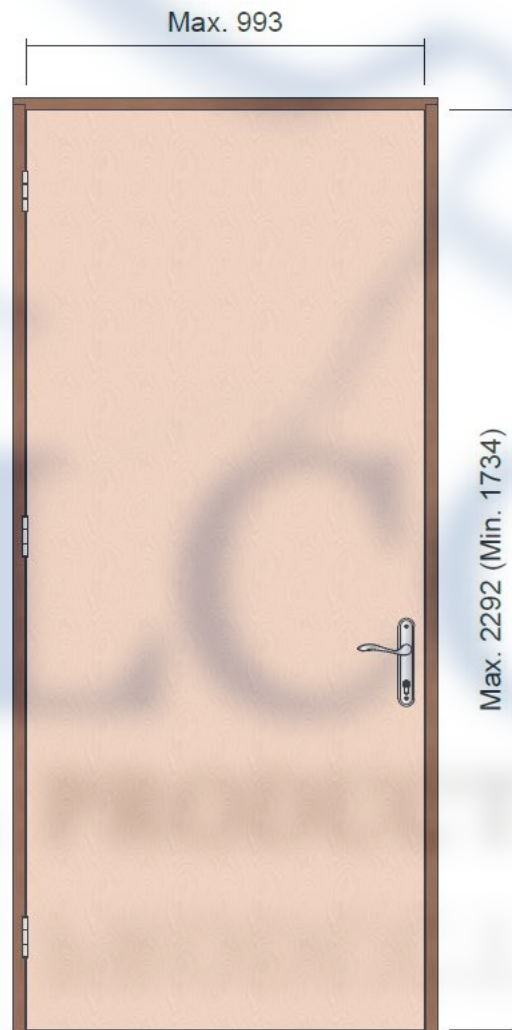

Fig. 5 – Drawing of front elevation of doorset to indicate maximum permissible leaf dimensions

7.2 Minimum leaf sizes

Size reduction is permitted in width without restriction according to the direct application rule in table B1 in BS EN 1634-1: 2014 + A1: 2018.

Reduction in leaf height is restricted based on the height of the multi-point lock (forend plate of the Surefire Classic = 1634mm (h)), as this cannot be removed for the purpose of maintaining the required fire resistance and smoke classification (the latch was engaged at all three locations for the purpose of the fire and smoke testing and cannot therefore be removed).

It has been deemed necessary to maintain at least 50mm distance from the top and the bottom of the forend of the locking system to maintain intumescent/smoke sealing at the top and bottom corners of the closing edge of the doorset. This will provide in excess of 100mm of perimeter intumescent sealing at the top and bottom of the closing edge frame reveal which is consistent with the rule regarding hinge repositioning (rule C.1.36 in BS EN 15269-3: 2012).

It has been necessary to use rule C.1.36 as there is no rule directly related to the reduction of leaf height and the reduced distance between the top/bottom of the forend or keeps of multi-point locks and rule C.1.36 best represents the situation of reducing the distance between the keeps of the multi-point lock and the top and bottom corners of the doorset).

Minimum height permitted:

Doorsets fitted with Surefire Classic locksets = 1734mm (h)

There must be a minimum of 50mm distance above and below the forend plate of the full height lock (i.e. in excess of 100mm between the top of the top keep and between the bottom of the bottom keep).

8 Door Frames

8.1 Timber Door Frames

Timber based door frames for the Stredor 44 EI30 FED product family must be constructed to meet the following specification based on the test evidence.

Material	Minimum Section Size (mm)		Min. Density (kg/m ³)
Softwood or Hardwood (excluding beech – fagus sylvatica)	Jambs	70 (w) x 29 (t) (excluding the stop)	510
	Head	70 (w) x 29 (t) (excluding the stop)	

Alternative softwood and hardwood timber (excluding beech) is permitted in accordance with EXAP rule B.2.3, providing the timber has a density equal to or greater than 510kg/m³

All door frame timber must be meet or exceed class J30 as specified in BS EN 942: 2007 (subject to adequate repair of any defects).

The door frame is to include a Minimum 15mm deep x Minimum 23mm wide solid rebated stop (see diagram below). The frame reveal is to be maintained at 47mm wide to accommodate the leaf width.

Frame joints must be trenched, as tested and with no gaps. Joints require mechanical fixing with 4 No. 80mm long x 5mm diameter screws.

The following diagram (Figure 1) depicts the frame profile and minimum dimensions:

A = Min. 70mm
B = Min. 44mm
C = Min. 15mm
D = Min. 23mm
E = 47mm
F = Min. 29mm

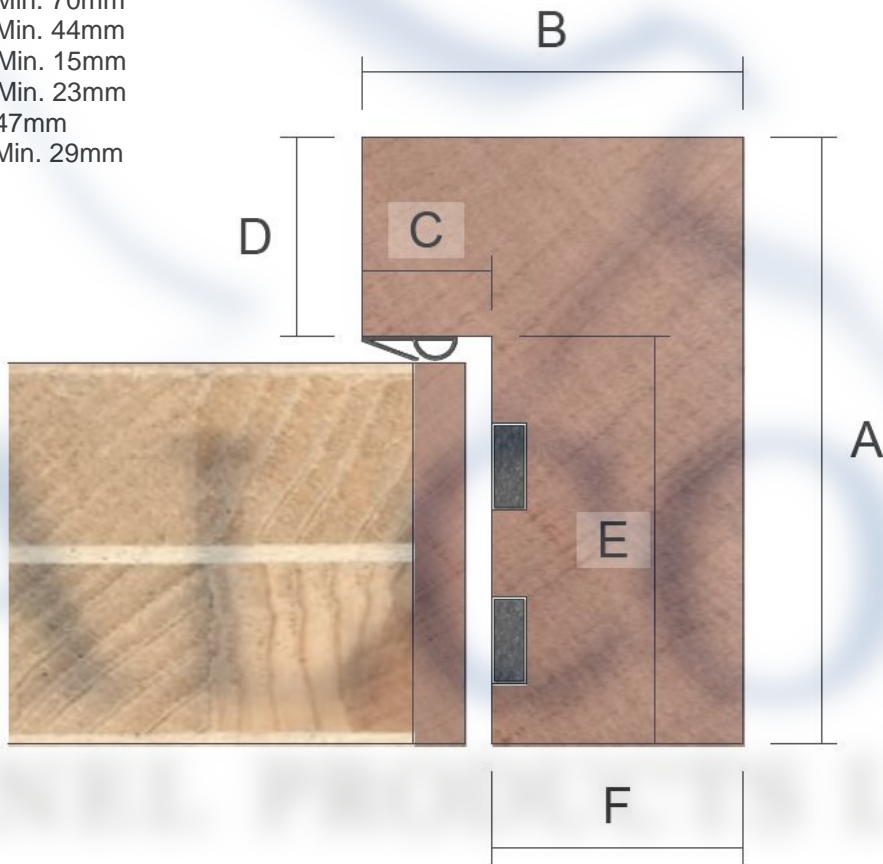

Fig. 6 – Door frame profile

Falcon Panel Products Ltd supports third-party certification for the processing, manufacture, installation and maintenance of fire door assemblies. This document remains the property of Falcon Panel Products Ltd. It is the responsibility of the reader to ensure that any product manufactured using the evidence within is fit for purpose. This document details a subset of evidence from an extensive testing regime covering a wide range of products. Further documentation can be found on our website at <https://www.falconpp.co.uk/doorinfo>

8.2 Thresholds

8.2.1 Aluminium Thresholds

The following product has been tested for use with the Stredor 44 EI30 FED product family covered by this field of application. Due to the smoke leakage requirement for the Stredor 44 EI30 FED product family (i.e. smoke leakage to be maintained without the threshold taped – see EXAP for smoke control: WF 428364), it is not possible to remove the threshold or change the threshold for an alternative product.

The threshold must be fitted on to a non-combustible flooring with a minimum Reaction to Fire class A2,fl,s1 as tested.

Element	Type	Dimensions (mm)	Location
Threshold	Sealed Tight Solutions Limited STH004 aluminium threshold	15 high x 47 deep (overall)	The threshold is to be screwed to the jambs using 2No. 4mmØ x 50mm long woodscrews



Fig. 7 – Profile of Sealed Tight Solutions Limited STH004 aluminium threshold

9 Door Leaf Glazing

9.1 General

The testing on the Stredor 44 EI30 FED door design included glazed apertures. The following sections detail the required glazing specification in terms of glazing systems, glass types, area permitted within the leaf, number of glazed apertures and position within the leaf.

The Stredor 44 EI30 FED door design was tested with the glazed area <25% of the leaf of area. According to rule E.1.2 this permits the glazed panel to be removed from the leaf to allow for solid leaf designs (i.e. unglazed).

The glazed panel has been tested in both directions with respect to exposure to fire test conditions and is therefore permitted in both directions with respect to exposure to fire test conditions.

The following glazing scope (sections 9.2 to 9.6) is limited based on the ambient smoke leakage requirement for the Stredor 44 EI30 FED doorset design. The scope has been taken from smoke EXAP WF 428364 and is based on the relevant EXAP rules taken from BS EN 15269-20: 2009 and BS EN 15269-3: 2012.

9.2 Single Apertures

It is not possible to increase the dimensions of the tested glazed apertures (rule E.1.5 in BS EN 15269-20: 2009).

It is possible to reduce the size of the tested glazing cut out by 50% from that tested (rule E.1.6 in BS EN 15269-3: 2012) to any aperture size.

Based on the maximum pane sizes tested the following aperture dimensions are permitted with the Stredor 44 EI30 FED doorset design:

9.2.1 Single Glazed Aperture Option:

Aperture Height (mm)	Maximum:	1540
	Minimum:	770
Aperture Width (mm)	Maximum:	400
	Minimum:	200
Aperture Area (m ²)	Maximum:	0.61
	Minimum:	0.305

9.3 Multiple Apertures

Multiple apertures are not permitted within the Stredor 44 EI30 FED door design.

9.4 Position of Apertures

It is possible to remove the glazed aperture from the door leaf due to the tested aperture area < 25% of the leaf area. Therefore the restrictions regarding increased distance between the edge of the glazing and perimeter of the door leaf given in E.1.13 of BS EN 15269-3: 2012 do not apply. The testing therefore allows the aperture to be relocated within the leaf subject to the following conditions:

Rule E.1.14 in BS EN 15269-3: 2012 does not allow the tested minimum distance between the glazed aperture and edge of the leaf to be decreased.

Using the above rules and the tested positions and dimensions of the glazing, the aperture can be moved within the following limitations.

The glazed aperture must meet the following position and spacing requirements:

- The glazed aperture must be no closer than 150mm to any leaf edge
- The glazed apertures must be spaced a minimum of 125mm from other apertures cut within the leaf (e.g. eye viewers and letter plates)

9.5 Glazing System

According to rule E.1.8 in BS EN 15269-3: 2012 it is not possible to allow alternative glazing materials and geometry of edge fixing techniques without additional testing. The following glazing system, bead shape and materials were tested with the Stredor 44 EI30 FED door design and must therefore be used when glazing the door leaf.

The number of each table provides the key to the components depicted in Fig 2.

1. Beading	
Reference	: Glazing Beads
Material	: Hardwood min 640kg/m ³ (excluding beech – fagus sylvatica)
Overall size	: 22 mm (h) x 19 mm (w) including a 15° degree splay and a 6mm x 6mm bolection

2. Bead fixings	
Fixing method	: 16-gauge x 50mm long SSS Pins Due to restriction on fixings for ambient temperature smoke leakage in BS EN 15269-20: 2009, alternative fixings are not permitted
Fixing distances from corners and centres	: 50mm from each corner at a maximum of 150mm centres and inserted at 35° to the plane of the glass

3. Glazing System (liner)	
Manufacturer	: Sealed Tight Solutions Limited
Reference	: STS 302 (2mm thick and trimmed to 15mm wide)
Material	: Graphite
Application method	: Fitted centrally lining the glazing aperture on all edges

4. Glazing System	
Manufacturer	: Sealed Tight Solutions Limited
Reference	: STS ST 105-3
Material	: Compressible closed cell foam tape: 9mm wide x 3mm thick
Application method	: Fitted between the glass and the glazing bead on both faces

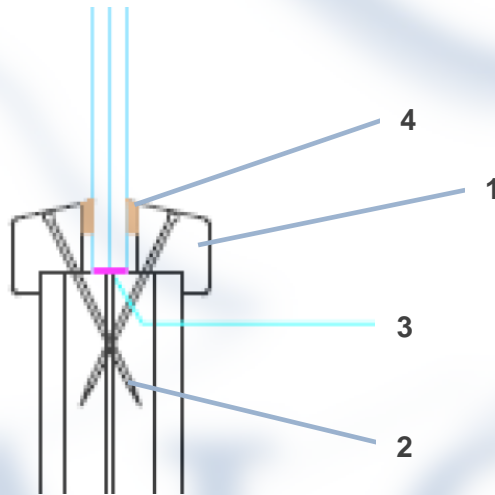

Fig 8: Cross section of tested and approved glazing system

9.6 Glass Types

The doorset design was tested with the following glass type, tested from both directions with respect to exposure to fire test conditions. Based on the test evidence referenced in this EXAP report it is not possible to substitute the glass with alternative glass types:

Single glazed unit / Glazing		
Manufacturer	:	Pilkington
Reference	:	Pyrostop 15 mm thick
Expansion allowance	:	5 mm tolerance all around (this includes the 2 mm thickness of the STS 302 glazing liner described in item 3 in section 9.5)
Overall thickness	:	15 mm thick

Falcon Panel Products Ltd supports third-party certification for the processing, manufacture, installation and maintenance of fire door assemblies. This document remains the property of Falcon Panel Products Ltd. It is the responsibility of the reader to ensure that any product manufactured using the evidence within is fit for purpose. This document details a subset of evidence from an extensive testing regime covering a wide range of products. Further documentation can be found on our website at <https://www.falconpp.co.uk/doorinfo>

10 Environmental Seals

The following smoke and weather seals have been tested and are approved for use with the Stredor 44 EI30 FED product family.

Due to the smoke leakage requirement for the Stredor 44 EI30 FED product family (i.e. smoke leakage to be maintained without the threshold taped – see EXAP for smoke control: WF 428364), it is not possible to remove the seals or change the seals for alternative products.

10.1 Option 1 Norseal Ltd

Element	Product	Dimensions (mm)	Location
Smoke and weather seal	Norseal Ltd – NOR710	11 x 10	Self-adhered in the corner of the stop and the frame reveal
	Norseal Ltd – NOR810S	12 x 20	Centrally rebated into the bottom edge of the leaf and screwed with 3 No. 20mm wood screws

10.2 Option 2 Sealed Tight Solutions Limited

Element	Product	Dimensions (mm)	Location
Smoke and weather seal	Sealed Tight Solutions Ltd – ST1009	10 x 9	Self-adhered in the corner of the stop and the frame reveal
	Sealed Tight Solutions Ltd – ST422	12 x 20	Centrally rebated into the bottom edge of the leaf and screwed with 3 No. 20mm wood screws

11 Intumescent Materials

Intumescent materials tested and approved for the Stredor 44 EI30 FED product family are as follows:

Element	Product	Size (mm)	Location
Frame reveal – head and jambs	PVC encased STS 104FO – Sealed Tight Solutions Limited	2 No. 10 x 4	Self-adhered into grooves 10mm apart within the frame reveal, with the first seal 7mm from the opening face of the door leaf
Hinges	Raw graphite – Sealed Tight Solutions Limited	1 thick	Both hinge blades bedded onto a minimum of one layer of gasket
Locks/latches (ERA Surefire)	Sealed Tight Solutions Limited - ERA Surefire Intumescent kit Pre-cut graphite gaskets	1 thick	Central and top and bottom lockcase fitted with pre-cut gaskets and centre and top and bottom keeps fitted with pre-cut gaskets
Door closer (Astra 4003 jamb mounted closer)	Raw graphite – Sealed Tight Solutions Limited	1 thick	Intumescent gasket to line the cut out for the closer
Letter plate (Royde and Tucker LP08 and ERA Fab&Fix Numail)	Graphite based intumescent – Sealed Tight Solutions Limited	2 thick x 40 wide (4mm total thickness)	Fitted lining the letter plate aperture – 2mm intumescent to be wrapped twice around letter plate channel
Eye viewer	Graphite based intumescent – Sealed Tight Solutions Limited	1 thick	Wrapped around the eye viewer body

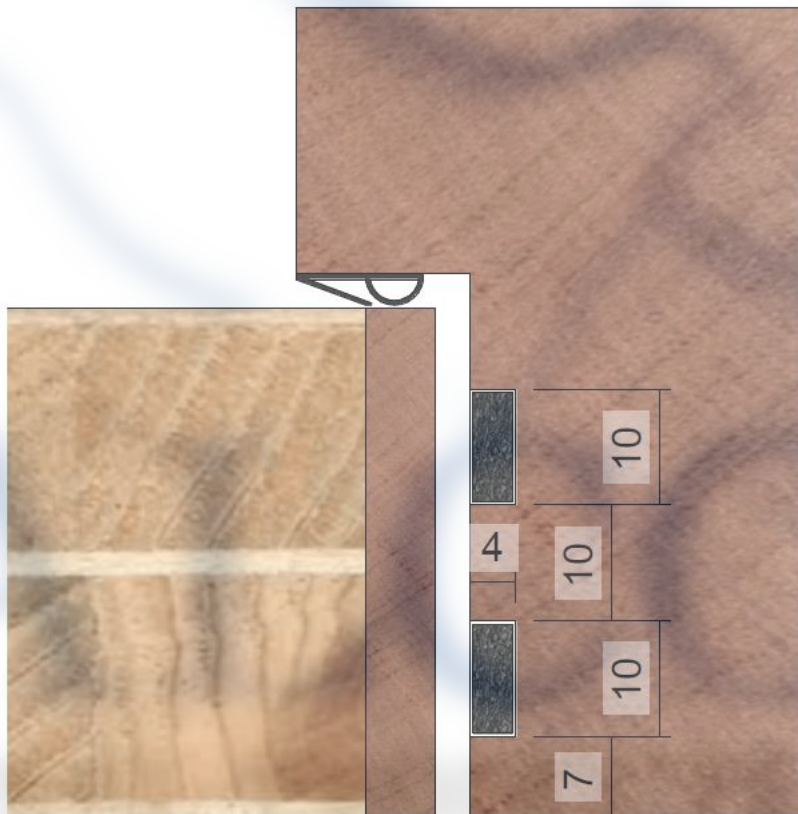

Fig. 9 – Frame profile indicating the required position of the perimeter intumescent seals (dimensions in mm)

12 Decorative and/or Protective Finishes

The following decorative and protective finishes may be used with the Stredor 44 EI30 FED doorset design:

12.1 Combustible Decorative Facings (on face of leaf)

Decorative facings meeting the following performance requirements are permitted on the face of the leaf because the door leaf satisfied the insulation criteria during test:

1. European reaction to fire class B - F.
2. Melting point of <math><660^{\circ}\text{C}</math>.

Notes:

1. Material must not return around the leaf edges
2. Timber veneer is permitted up to 3mm thick
3. All other materials must not exceed 2mm thick (e.g. laminate, plastic, cloth, leather, etc.).

The following rules from BS EN 15269-3: 2012 have been used to consider the possible extended scope of application for combustible decorative facings on leaves: A.5.1.

12.2 Paint Finish (face and edge of leaf)

According to the direct application (DIAP) rule 13.2.3.1 given in BS EN 1634-1: 2014 + A1: 2018 it is possible to add paint to the door, including the edges, providing the paint finish is not expected to contribute to the fire resistance of the door and providing the test specimens were tested unfinished.

The Stredor 44 EI30 FED door design was tested unfinished and can therefore be painted in accordance with the above DIAP rule.

The intumescent, smoke and weather seals must not be painted.

12.3 Applied Mouldings

The Stredor 44 EI30 FED door design has been tested in WF 426419 with face applied mouldings. According to rule A.5.28 in BS EN 15269-3, it is possible to add timber-based mouldings to the door leaf, subject to the following:

1. If mouldings are only applied to only one face of the leaf, the mouldings must not cover more than 25% of the surface of the leaf face
2. If mouldings are applied to both faces of the leaf, the mouldings must not cover more than 25% of the surface of each leaf face (as per the rule in clause 1 above) AND the mass of the leaf must not be increased by more than 25 %.
3. The mouldings are to be applied with PU glue and pinned with 18 gauge stainless steel pins as tested

12.4 Non-Combustible Decorative Facings (on face of leaf)

Decorative facings meeting the following performance requirements are permitted on the face of the leaf:

1. European reaction to fire class A1 or A2 (the A1 and A2 classification has been taken directly from the EXAP standard. No smoke (S) or droplet requirement (d) is given)
2. Melting point $\geq 660^{\circ}\text{C}$.

NB: This could include materials such as glass sheet, stone, marble, ceramic tile or steel.

Notes:

1. The total increase in leaf weight must not exceed 25%.
2. The facings must be attached by adhesive only.
3. Items of hardware such as door handles must not act as a mechanical fixing for the facing material.
4. The facing must not be added to the area of the leaf behind the door frame rebates (door stop).
5. Any facing applied to the leaf must not wrap around the edges of the leaf to ensure that the perimeter seals are not affected by the application.

The following rules from BS EN 15269-3: 2012 have been used to consider the possible extended scope of application for non-combustible decorative facings on the face of leaves: A.5.5.

See section 13.11 for approved specification when fitting push plates and kick plates.

13 Tested Hardware

13.1 General

The following hardware has been successfully incorporated in the tests on the Stredor 44 EI30 FED door design and is approved for use. Specific restrictions related to hardware are given below the table for each item of hardware as appropriate (sections 13.2 to 13.11). The hardware must remain as tested unless otherwise stated:

Element	Product	Dimensions (mm)
Hinges	Zoo ZHSS243RS butt hinge	102 (high) x 31 (wide) blade size
	Royde & Tucker H207	102 (high) x 30 (wide) blade size
Locks and latches	ERA Surefire Classic	1634 x 20 x 2 (forend size) 214 x 60 x 14 (centre case size) 150 x 41 x 14 (top and bottom hook bolt case size)
Handle	ERA 1X000 stainless steel lever handle	240 x 140
	Stanza ZPZ090SC	-
Lock Cylinder	ERA Fortress 3* T/Turn	75mm deep (barrel) x 17mm diameter
Surface Mounted Closer	Hoppe AR1500	248 wide x 45 high x 53 projection (body)
Jamb Mounted Closer	Astra 4003 Jamb mounted closer	Body: 216 long x 28 high x 28 wide Fixing plate: 106 high x 32 wide
Letterplates	ERA Fab&Fix Numail Door letterplate with security cowl	310 x 75 (footprint)
Eye viewer	Sealed Tight Solutions Limited 4008	14Ø body 23Ø to external face
	ERA Fab&Fix Spyhole	12Ø body
Door knocker	ERA Ingot Door Knocker – 4A550	140 high x 52.5 wide x 28 deep
Security Chain	ERA PVCu/Timber Door Chain 791-65	-
Numerals	ERA Fab&Fix Door Numerals FFNUM8BC	80 high x 4.5 thick

13.1.1 Notes

1. Hinges tested on Type A leaves have been considered acceptable for use on Type B leaves (and vice versa) based on the following rules taken from BS EN 15269-3: 2012. Consideration has also been given to using the supporting evidence to permit alternative items of hardware for 30 minute fire resisting integrity and insulation performance, based on the hardware specification tested in WF 426419:
 - a. C.1.22 – increased hinge dimensions
 - b. C.1.23 – decreased hinge dimensions
 - c. C.1.24 – alternative fixings
 - d. C.1.29 – change of hinge manufacturer
2. Locksets tested on Type A leaves have been considered acceptable for use on Type B leaves (and vice versa) based on the following rules taken from BS EN 15269-3: 2012. Consideration has also been given to using the supporting evidence to permit alternative items of hardware for 30 minute fire resisting integrity and insulation performance, based on the hardware specification tested in WF 426419:
 - a. C.1.1 – alternative locksets permitted providing they are suitable for use on the doorsets and they have passed a test to EN 1634-1 or EN 1634-2.
3. Handles tested on Type A leaves have been considered acceptable for use on Type B leaves (and vice versa) based on the following rules taken from BS EN 15269-3: 2012. Consideration has also been given to using the supporting evidence to permit alternative items of hardware for 30 minute fire resisting integrity and insulation performance, based on the hardware specification tested in WF 426419:
 - a. C.1.17 – alternative handles are permitted providing they are surface mounted
4. The letterplate tested on Type A leaves has been considered acceptable for use on Type B leaves based on the following rules taken from BS EN 15269-3: 2012. Consideration has also been given to using the supporting evidence to permit alternative items of hardware for 30 minute fire resisting integrity and insulation performance, based on the hardware specification tested in WF 426419:
 - a. C.1.57 – add a letter plate providing the evidence for the letter plate has been generated on a similarly constructed door leaf and of the same or thinner leaf thickness.

13.2 Hinges

It is possible to vary the tested hinge specification within the following parameters:

13.2.1 Hinge Fixings

1. The hinges must be fixed with minimum 4No. steel screws
2. All fixing points must be utilised
3. The position of the fixings relative to width of the hinge leaves shall remain the same as tested.

The following rules from BS EN 15269-3: 2012 have been used to consider the possible extended scope of application for hinge fixings: C.1.22, C.1.24.

13.2.2 Number of Hinges

The door leaf must be fitted with a minimum of 3 hinges, which must meet the positioning requirements outlined in section 13.2.5.

It is possible to increase the number of hinges in accordance with direct application rule 13.2.5 in BS EN 1634-1: 2014 + A1: 2018 and because the hinges do not interrupt the perimeter smoke seal (to maintain the smoke leakage performance, see rule 13.2.4 in BS EN 15269-20: 2009)

13.2.3 Hinge Material

It is not permitted to change the material of the tested hinge based on the test evidence listed in section 3 and considering rule C.1 and C.1.30 in BS EN 15269-3: 2012.

13.2.4 Alternative Hinges

Alternative hinges to those listed in section 13.1 are not permitted without additional test evidence.

The following rules from BS EN 15269-3: 2012 have been used to consider the possible extended scope of application for alternative hinges: C.1.29, C.1.30, C.1.31.

13.2.5 Hinge Positioning

It is possible to vary the hinge positioning for the Stredor 44 EI30 FED product family within the following parameters:

1. The position of the top hinge may be located between 100 to 150mm from the top of the door leaf (measured from the top of the hinge)
2. The bottom hinge may be located between 100mm and 180mm from the bottom of the leaf (measured from the bottom of the hinge)
3. The intermediate hinge was tested at 759mm from the top hinge (bottom of top hinge to top of intermediate hinge) and 758mm from the bottom hinge (bottom of intermediate hinge to top of bottom hinge). It is permitted to move the intermediate hinge but the distance between the top hinge and intermediate hinge OR between the intermediate hinge and bottom hinge must remain as tested (restriction based on the Cat A performance of doorset A in WF416690). If either of these distances cannot be maintained it is permitted to add an additional hinge so that the maximum distance between the hinges is not increased

The following rules from BS EN 15269-3: 2012 have been used to consider the possible extended scope of application for hinge positioning: C.1.35, C.1.36, C.1.37, C.1.38, C.1.39.

13.3 Door Closers

13.3.1 Alternative Door Closers

The Stredor 44 EI30 FED product family may be fitted with the following tested closers:

- Hoppe AR1500 surface mounted closer
- Astra 4003 Jamb mounted closer
- Dormakaba TS93 (alternative surface mounted closer has been permitted for Type A and Type B Stredor 44 based on the door design tested in WF 421795 and using rule C.1.44)

13.3.2 Door Closer Positioning

Surface mounted

Surface mounted door closers may be fitted on either face of the door (exposed or unexposed) due to the location of the tested door closers and the tested latched configuration.

Jamb mounted

According to rule C.1.41 the position of the jamb mounted closer must remain as tested i.e. 849mm from the bottom of the door leaf to the centreline of the closer.

The following rules from BS EN 15269-3: 2012 have been used to consider the possible extended scope of application for door closers: C.1.40, C.1.41, C.1.43, C.1.44, C.1.45.

13.4 Door Signs

Door signs meeting the following performance requirements are permitted on the face of the leaf:

1. Reaction to fire class A1 or A2.
2. Melting point $\geq 660^{\circ}\text{C}$.

NB: This could include materials such as glass sheet, stone, marble, ceramic tile or steel.

Limitations:

1. The total increase in leaf weight must **not** exceed 25%.
2. The sign/s must be attached by adhesive only.
3. The sign/s must **not** be added to the area of the leaf behind the door frame rebates.
4. Consideration must be given to any non-combustible facings already fitted to the leaf in terms of total increase in leaf weight.

The following rules from BS EN 15269-3: 2012 have been used to consider the possible extended scope of application for door signs: A.5.5, A.5.15, C.1.51.

13.5 Lock Cylinders

13.5.1 Alternative Manufacturer

The following tested lock cylinder is permitted with the Stredor 44 EI30 FED product family:

- ERA Fortress 3* T/Turn

13.5.2 Cylinder Configuration

It is not permitted to exchange a double cylinder for a single cylinder or cylinder and thumb-turn/knob or omit the cylinder completely without additional test evidence

The following rules from BS EN 15269-3: 2012 have been used to consider the possible extended scope of application for lock cylinders: C.1.64, C.1.65.

13.6 Door Knockers

It is permitted to fit the following door knockers to the Stredor 44 EI30 FED product family based on the test evidence generated in WF 416690:

- ERA Ingot Door Knocker – 4A550

The door knocker must be position at least 150mm from the edge of the door leaf and 125mm from any other apertures within the door leaf (i.e. glazing, letter plates, eye viewers etc.)

13.7 Letter Plates

The following letter plate is approved for use with the Stredor 44 EI30 FED product family. The letter plate has been fire tested and matches the letter plate that has been tested and approved in the EXAP for smoke control (WF 428364). The letter plate must be fitted with the tested and approved intumescent specification detailed in section 11 of this report:

- ERA Fab&Fix Numail Door letterplate with security cowl

According to rule C.1.59 it is not possible to move the letter plate to an alternative height from that tested (EXAP requires a minimum and maximum height to be tested to allow variability in letter plate positioning). The letter plate must therefore be fitted at 850mm from the threshold. According to rule C.1.60 the letter plate can be fitted to the side of the tested position but must be no closer than 145mm to the edge of the door leaf.

Additionally the cut out for the letter plate must be at least 125mm form any other apertures within the leaf (i.e. glazing, letter plates, eye viewers etc.)

13.8 Numerals

Numerals have been tested with the Stredor 44 EI30 FED product family and are approved with the following specification:

	Make/type	Size (mm)
Numerals	ERA Fab&Fix Door Numerals FFNUM8BC	Maximum permitted - 80 high x 4.5 thick

13.9 Door Chain

The ERA PVCu/Timber Door Chain 791-65 has been tested with the Stredor 44 EI30 FED product family and is approved for use. Fixings must not be inserted into the lipping of the door leaf

13.10 Eye Viewer

The following eye viewers are permitted with the Stredor 44 EI30 FED product family and are approved for use:

- Sealed Tight Solutions Limited 4008
- ERA Fab&Fix Spyhole

The eye viewers must be protected with intumescent as detailed in section 11.

Eye viewers must be positioned at least 150mm from the edge of the door leaf and 125mm from any other apertures within the door leaf (e.g. glazing, letter plate etc.)

It is only permitted to fit one eye viewer in the leaf.

13.11 Push Plates and Kick Plates

According to rules A.5.20 and A.5.21 in BS EN 15269-3: 2012 it is possible to add push plates and kick plates to the door leaf meeting the following requirements:

13.11.1 Screw Fixed

Possible for horizontal plates across the full opening width of the closing face and full leaf width of the opening face to a maximum of 500 mm high. Vertical plates no more than 200 mm wide running the clear opening height on the closing face and full height of the leaf on the opening face.

Maximum area permitted to be covered by plates/signs is 40 % of the clear opening area or 1 m², whichever is the smaller. Plate thickness to be limited to 2 mm and fixed with maximum 25 mm long screws and a minimum of 200 mm centres along the length of the plates.

13.11.2 Glue fixed

Possible for plates across the full opening size of the closing face and full leaf size of the opening face and up to a maximum of 2 mm thick and not restrained by mechanical means, e.g. by building hardware. Maximum area permitted to be covered by plates is 40 % of the clear opening area. May be applied to the face of the leaf only, i.e. not the edge of the leaf.

14 Leaf/Frame Gaps

Leaf/frame gaps and alignment tolerances must fall within the following range:

Location	Dimension
Leaf/frame edge gaps	A minimum of 2.5mm and a maximum of 4mm ¹
Alignment tolerances	Leaves must not be proud of the door frame by more than 1.5mm
Threshold	Maximum gap of 8mm ¹ between bottom of door leaf and threshold (see section 10 for approved aluminium threshold profiles)

1. The door edge gaps stated above (leaf/frame and threshold) are limited by the gaps tested for smoke control (see WF 428364)

15 Supporting Construction and Attachment (Technique) of Door Frame

The Stredor 44 EI30 FED doorset design must be mounted in the following supporting constructions and using approved attachment techniques:

15.1 Supporting Construction

The supporting construction in which the doorset is mounted must have a fire resistance equal to or greater than the fire resistance of the doorset.

The fire resistance of the supporting construction shall have been established separately in a previous test.

According to EXAP rules B.1.4 it is possible to vary the position of the door frame within the supporting construction providing the door frame does not project beyond the supporting construction more than tested.

According to EXAP rules F.1.1 and F.1.2 the doorset may be hung in a rigid standard supporting construction or a flexible standard supporting construction meeting the following requirements:

- The doorset has been tested in low density low density rigid standard supporting construction as specified in EN 1363-1 and can therefore be mounted in the same manner in alternative walls provided the density and the thickness of the wall are equal to or greater than that in which the doorset was tested
- The doorset has been tested in one of the flexible standard supporting constructions specified in EN 1363-1 and can therefore be mounted in the same manner in a wall or partition which is of the board covered type with studs made from metal or timber.

15.2 Fixings

The door frame is to be fixed to the supporting construction using a minimum of 5No. x 80mm x 5mm Ø steel screw fixings per jamb. The screws are to be appropriate for the substrate of the supporting construction.

The top and bottom screw fixings are to be located at 100-180mm from the top and bottom corners of the door frame with the remaining screws spaced at approx. 400-500mm centres.

It is permitted to increase the size and number of fixings but not decrease.

The following rules from BS EN 15269-3: 2012 have been used to consider the possible extended scope of application for the supporting construction: F.1.3, F.1.4, F.1.5.

15.3 Sealing to Structural Opening

The gap between the rear of the door frame and the structural opening must be between 4mm and 19mm to accommodate the sealing material.

It is not permitted to install the door frame without the tested sealing material between the door frame and the supporting construction.

Approved sealing materials as tested for the Stredor 44 EI30 FED product family are as follows:

15.3.1 Approved Sealing Method

Gap between rear of frame and structural opening: Min 4mm to Max 19mm

Sealing method:

A minimum of 60mm deep infill of Rockwool RWA 45 or Rockwool FLEXI stone based mineral fibre tightly packed and friction fitted between the rear of the frame and structural opening.

The mineral fibre is to be capped with a nominally 10mm deep (minimum) bead of intumescent mastic on both sides of the rockfibre to finish level with the face of the door frame. The mastic one be one of the following tested and approved types:

- Pyromas A – Mann McGowan
- Fire Sealant 300 - Everbuild

Approved architraves:

For door frame to structural opening gaps up to 12mm architrave is not required. For gaps between 12mm and 19mm, architraves meeting the following specification must be fitted:

- Timber or MDF architraves measuring a minimum of 45mm (w) x 18mm (t) and overlapping the gap by a minimum 10mm on the face of the door frame and the wall. The architrave must be pin fixed in position.

The sealing method described above has been tested for fire resistance (see section 3 for evidence) and matches that required in the smoke EXAP WF 428364.

16 Application Range – Product Family

The precise scope and design options for the Stredor 44 EI30 FED product family with 30 minutes integrity and insulation performance, which provide the boundaries for the product family, are defined within this EXAP document.

17 Fire Performance Parameters

The fire performance parameters for the range of designs covered in this extended field of application report for the Stredor 44 EI30 FED product family is tabulated below:

Integrity	
Cotton pad	30 (Thirty) minutes
Continuous flaming	30 (Thirty) minutes
Gap gauges	30 (Thirty) minutes
Insulation	
Average	30 (Thirty) minutes
Maximum temperature rise (normal procedure for insulation 2)	30 (Thirty) minutes
Maximum temperature rise (supplementary procedure for insulation 1)	N/A
Radiation	30 (Thirty) minutes

The Falcon Panel Products, Stredor 44 EI30 FED doorset designs detailed in this EXAP report are defined in clause 7.5.5 of BSEN 13501-2 as fire doorset assemblies. Their function is to resist fire in respect of the fire performance characteristics given in clause 5 of BS EN 13501-2: 2016.

18 Declaration by the Applicant

1. We confirm that the component or element of structure, which is the subject of this extended field of application document, has not to our knowledge been subjected to a fire test to the Standard against which this extended application is being made.
2. We agree to withdraw this extended field of application document from circulation should the component or element of structure be the subject of a fire test to the Standard against which this extended field of application is being made.
3. We are not aware of any information that could adversely affect the conclusions of this extended field of application.
4. If we subsequently become aware of any such information we agree to ask the assessing authority to withdraw the extended field of application.

Signed:

Name:

For and on behalf of: Falcon Panel Products

Falcon Panel Products Ltd supports third-party certification for the processing, manufacture, installation and maintenance of fire door assemblies. This document remains the property of Falcon Panel Products Ltd. It is the responsibility of the reader to ensure that any product manufactured using the evidence within is fit for purpose. This document details a subset of evidence from an extensive testing regime covering a wide range of products. Further documentation can be found on our website at <https://www.falconpp.co.uk/doorinfo>

19 Limitations

The following limitations apply to this extended application report:

1. This extended field of application document does not represent type approval or certification of the product.
2. This extended field of application document addresses itself solely to the elements and subjects discussed and do not cover any other criteria. All other details not specifically referred to should remain as tested or assessed.
3. This extended field of application document is issued on the basis of test data and information to hand at the time of issue. If contradictory evidence becomes available, Warringtonfire reserves the right to withdraw the extended application unconditionally but not retrospectively.
4. Opinions and interpretations expressed herein are outside the scope of UKAS accreditation.
5. This extended field of application document relates only to those aspects of design, materials and construction that influence the performance of the element(s) under fire resistance test conditions. It does not purport to be a complete specification ensuring fitness for purpose and long-term serviceability. It is the responsibility of the client to ensure that the element conforms to recognised good practice in all other respects and that, with the incorporation of the guidance given in this extended application, the element is suitable for its intended purpose.
6. This extended field of application considers the performance likely to be demonstrated by the Stredor 44 EI30 FED product if it were to be tested in accordance with BS EN 1634-1: 2014 + A1: 2018, on the basis of the test evidence referred to in this report and the relevant EXAP rules taken from BS EN 15269-3: 2012. We express no opinion as to whether that evidence, and/or this extended field of application, would be regarded by any Building Control authority as sufficient for that or any other purpose. This field of application has been written for the purpose of classifying the fire resistance of the Stredor 44 EI30 FED product family to BS EN 13501-2: 2016 and we cannot opine on whether it will be accepted by Building Control authorities or any other third parties for any purpose.
7. This report may only be reproduced in full. Extracts or abridgements of reports shall not be published without permission of Warringtonfire. All work and services carried out by Warringtonfire Testing and Certification Limited are subject to, and conducted in accordance with, the Standard Terms and Conditions of Warringtonfire Testing and Certification Limited, which are available at <https://www.element.com/terms/terms-and-conditions> or upon request.

20 Validity

This extended application report is not valid unless it incorporates the declaration given in Section 18 duly signed by the applicant.

Signature:		
Name:	P Barker	R Axe
Title:	Technical Manager	Technical Manager

Falcon Panel Products Ltd supports third-party certification for the processing, manufacture, installation and maintenance of fire door assemblies. This document remains the property of Falcon Panel Products Ltd. It is the responsibility of the reader to ensure that any product manufactured using the evidence within is fit for purpose. This document details a subset of evidence from an extensive testing regime covering a wide range of products. Further documentation can be found on our website at <https://www.falconpp.co.uk/doorinfo>

Appendix A

Revisions

Revision	Warringtonfire Reference	Date	Description

Falcon Panel Products Ltd supports third-party certification for the processing, manufacture, installation and maintenance of fire door assemblies. This document remains the property of Falcon Panel Products Ltd. It is the responsibility of the reader to ensure that any product manufactured using the evidence within is fit for purpose. This document details a subset of evidence from an extensive testing regime covering a wide range of products. Further documentation can be found on our website at <https://www.falconpp.co.uk/doorinfo>